



Department
for Education

National Centre
for Excellence in the
Teaching of Mathematics



Mathematics guidance: key stages 1 and 2

**Non-statutory guidance for the national
curriculum in England**

Year 4

June 2020

What is included in this document?

This document is one chapter of the full publication Mathematics guidance: key stages 1 and 2 Non-statutory guidance for the national curriculum in England.

An overview of the ready-to-progress criteria for all year groups is provided below, followed by the specific guidance for year 4.

To find out more about how to use this document, please read the introductory chapter.

Ready-to-progress criteria: year 1 to year 6

The table below is a summary of the ready-to-progress criteria for all year groups.

Strand	Year 1	Year 2	Year 3	Year 4	Year 5	Year 6
NPV	1NPV-1 Count within 100, forwards and backwards, starting with any number.		3NPV-1 Know that 10 tens are equivalent to 1 hundred, and that 100 is 10 times the size of 10; apply this to identify and work out how many 10s there are in other three-digit multiples of 10.	4NPV-1 Know that 10 hundreds are equivalent to 1 thousand, and that 1,000 is 10 times the size of 100; apply this to identify and work out how many 100s there are in other four-digit multiples of 100.	5NPV-1 Know that 10 tenths are equivalent to 1 one, and that 1 is 10 times the size of 0.1. Know that 100 hundredths are equivalent to 1 one, and that 1 is 100 times the size of 0.01. Know that 10 hundredths are equivalent to 1 tenth, and that 0.1 is 10 times the size of 0.01.	6NPV-1 Understand the relationship between powers of 10 from 1 hundredth to 10 million, and use this to make a given number 10, 100, 1,000, 1 tenth, 1 hundredth or 1 thousandth times the size (multiply and divide by 10, 100 and 1,000).
		2NPV-1 Recognise the place value of each digit in two-digit numbers, and compose and decompose two-digit numbers using standard and non-standard partitioning.	3NPV-2 Recognise the place value of each digit in <i>three</i> -digit numbers, and compose and decompose <i>three</i> -digit numbers using standard and non-standard partitioning.	4NPV-2 Recognise the place value of each digit in <i>four</i> -digit numbers, and compose and decompose <i>four</i> -digit numbers using standard and non-standard partitioning.	5NPV-2 Recognise the place value of each digit in numbers with up to 2 decimal places, and compose and decompose numbers with up to 2 decimal places using standard and non-standard partitioning.	6NPV-2 Recognise the place value of each digit in numbers up to 10 million, including decimal fractions, and compose and decompose numbers up to 10 million using standard and non-standard partitioning.
	1NPV-2 Reason about the location of numbers to 20 within the linear number system, including comparing using < > and =	2NPV-2 Reason about the location of any two-digit number in the linear number system, including identifying the previous and next multiple of 10.	3NPV-3 Reason about the location of any <i>three</i> -digit number in the linear number system, including identifying the previous and next multiple of 100 and 10.	4NPV-3 Reason about the location of any <i>four</i> -digit number in the linear number system, including identifying the previous and next multiple of 1,000 and 100, and rounding to the nearest of each.	5NPV-3 Reason about the location of any number with up to 2 decimals places in the linear number system, including identifying the previous and next multiple of 1 and 0.1 and rounding to the nearest of each.	6NPV-3 Reason about the location of any number up to 10 million, including decimal fractions, in the linear number system, and round numbers, as appropriate, including in contexts.

Strand	Year 1	Year 2	Year 3	Year 4	Year 5	Year 6
NPV			3NPV-4 Divide 100 into 2, 4, 5 and 10 equal parts, and read scales/number lines marked in multiples of 100 with 2, 4, 5 and 10 equal parts. →	4NPV-4 Divide 1,000 into 2, 4, 5 and 10 equal parts, and read scales/number lines marked in multiples of 1,000 with 2, 4, 5 and 10 equal parts. →	5NPV-4 Divide 1 into 2, 4, 5 and 10 equal parts, and read scales/number lines marked in units of 1 with 2, 4, 5 and 10 equal parts. →	6NPV-4 Divide powers of 10, from 1 hundredth to 10 million, into 2, 4, 5 and 10 equal parts, and read scales/number lines with labelled intervals divided into 2, 4, 5 and 10 equal parts.
					5NPV-5 Convert between units of measure, including using common decimals and fractions.	
NF	1NF-1 Develop fluency in addition and subtraction facts within 10. →	2NF-1 Secure fluency in addition and subtraction facts within 10, through continued practice. →	3NF-1 Secure fluency in addition and subtraction facts that bridge 10, through continued practice.			
	1NF-2 Count forwards and backwards in multiples of 2, 5 and 10, up to 10 multiples, beginning with any multiple, and count forwards and backwards through the odd numbers. →		3NF-2 Recall multiplication facts, and corresponding division facts, in the 10, 5, 2, 4 and 8 multiplication tables, and recognise products in these multiplication tables as multiples of the corresponding number. →	4NF-1 Recall multiplication and division facts up to 12×12 , and recognise products in multiplication tables as multiples of the corresponding number. →	5NF-1 Secure fluency in multiplication table facts, and corresponding division facts, through continued practice.	
				4NF-2 Solve division problems, with two-digit dividends and one-digit divisors, that involve remainders, and interpret remainders appropriately according to the context.		
			3NF-3 Apply place-value knowledge to known additive and multiplicative number facts (scaling facts by 10). →	4NF-3 Apply place-value knowledge to known additive and multiplicative number facts (scaling facts by 100) →	5NF-2 Apply place-value knowledge to known additive and multiplicative number facts (scaling facts by 1 tenth or 1 hundredth).	

Strand	Year 1	Year 2	Year 3	Year 4	Year 5	Year 6
AS	1AS-1 Compose numbers to 10 from 2 parts, and partition numbers to 10 into parts, including recognising odd and even numbers.	2AS-1 Add and subtract across 10.	3AS-1 Calculate complements to 100.			6AS/MD-1 Understand that 2 numbers can be related additively or multiplicatively, and quantify additive and multiplicative relationships (multiplicative relationships restricted to multiplication by a whole number).
	1AS-2 Read, write and interpret equations containing addition (+), subtraction (-) and equals (=) symbols, and relate additive expressions and equations to real-life contexts.	2AS-2 Recognise the subtraction structure of 'difference' and answer questions of the form, "How many more...?".	3AS-2 Add and subtract up to three-digit numbers using columnar methods.			6AS/MD-2 Use a given additive or multiplicative calculation to derive or complete a related calculation, using arithmetic properties, inverse relationships, and place-value understanding.
		2AS-3 Add and subtract within 100 by applying related one-digit addition and subtraction facts: add and subtract only ones or only tens to/from a two-digit number.	3AS-3 Manipulate the additive relationship: Understand the inverse relationship between addition and subtraction, and how both relate to the part-part-whole structure. Understand and use the commutative property of addition, and understand the related property for subtraction.			6AS/MD-3 Solve problems involving ratio relationships.
		2AS-4 Add and subtract within 100 by applying related one-digit addition and subtraction facts: add and subtract any 2 two-digit numbers.				6AS/MD-4 Solve problems with 2 unknowns.

Strand	Year 1	Year 2	Year 3	Year 4	Year 5	Year 6
MD		2MD–1 Recognise repeated addition contexts, representing them with multiplication equations and calculating the product, within the 2, 5 and 10 multiplication tables.	3MD–1 Apply known multiplication and division facts to solve contextual problems with different structures, including quotitive and partitive division.	4MD–1 Multiply and divide whole numbers by 10 and 100 (keeping to whole number quotients); understand this as equivalent to making a number 10 or 100 times the size. →	5MD–1 Multiply and divide numbers by 10 and 100; understand this as equivalent to making a number 10 or 100 times the size, or 1 tenth or 1 hundredth times the size.	For year 6, MD ready-to-progress criteria are combined with AS ready-to-progress criteria (please see above).
		2MD–2 Relate grouping problems where the number of groups is unknown to multiplication equations with a missing factor, and to division equations (quotitive division).		4MD–2 Manipulate multiplication and division equations, and understand and apply the commutative property of multiplication.	5MD–2 Find factors and multiples of positive whole numbers, including common factors and common multiples, and express a given number as a product of 2 or 3 factors.	
				4MD–3 Understand and apply the distributive property of multiplication. →	5MD–3 Multiply any whole number with up to 4 digits by any one-digit number using a formal written method.	
					5MD–4 Divide a number with up to 4 digits by a one-digit number using a formal written method, and interpret remainders appropriately for the context.	

Strand	Year 1	Year 2	Year 3	Year 4	Year 5	Year 6
F			3F-1 Interpret and write proper fractions to represent 1 or several parts of a whole that is divided into equal parts.			6F-1 Recognise when fractions can be simplified, and use common factors to simplify fractions.
			3F-2 Find unit fractions of quantities using known division facts (multiplication tables fluency). →		5F-1 Find non-unit fractions of quantities.	6F-2 Express fractions in a common denomination and use this to compare fractions that are similar in value.
			3F-3 Reason about the location of any fraction within 1 in the linear number system. →	4F-1 Reason about the location of mixed numbers in the linear number system.		6F-3 Compare fractions with different denominators, including fractions greater than 1, using reasoning, and choose between reasoning and common denomination as a comparison strategy.
				4F-2 Convert mixed numbers to improper fractions and vice versa.	5F-2 Find equivalent fractions and understand that they have the same value and the same position in the linear number system.	
			3F-4 Add and subtract fractions with the same denominator, within 1. →	4F-3 Add and subtract improper and mixed fractions with the same denominator, including bridging whole numbers.	5F-3 Recall decimal fraction equivalents for $\frac{1}{2}$, $\frac{1}{4}$, $\frac{1}{5}$ and $\frac{1}{10}$, and for multiples of these proper fractions.	
G	1G-1 Recognise common 2D and 3D shapes presented in different orientations, and know that rectangles, triangles, cuboids and pyramids are not always similar to one another. →	2G-1 Use precise language to describe the properties of 2D and 3D shapes, and compare shapes by reasoning about similarities and differences in properties. →	3G-1 Recognise right angles as a property of shape or a description of a turn, and identify right angles in 2D shapes presented in different orientations.		5G-1 Compare angles, estimate and measure angles in degrees ($^{\circ}$) and draw angles of a given size.	

Strand	Year 1	Year 2	Year 3	Year 4	Year 5	Year 6
G					5G–2 Compare areas and calculate the area of rectangles (including squares) using standard units.	
	1G–2 Compose 2D and 3D shapes from smaller shapes to match an example, including manipulating shapes to place them in particular orientations. →		3G–2 Draw polygons by joining marked points, and identify parallel and perpendicular sides. →	4G–1 Draw polygons, specified by coordinates in the first quadrant, and translate within the first quadrant. →		6G–1 Draw, compose, and decompose shapes according to given properties, including dimensions, angles and area, and solve related problems.
				4G–2 Identify regular polygons, including equilateral triangles and squares, as those in which the side-lengths are equal and the angles are equal. Find the perimeter of regular and irregular polygons.		
				4G–3 Identify line symmetry in 2D shapes presented in different orientations. Reflect shapes in a line of symmetry and complete a symmetric figure or pattern with respect to a specified line of symmetry.		

Year 4 guidance

Ready-to-progress criteria

Year 3 conceptual prerequisite	Year 4 ready-to-progress criteria	Future applications
Know that 10 tens are equivalent to 1 hundred, and that 100 is 10 times the size of 10.	4NPV-1 Know that 10 hundreds are equivalent to 1 thousand, and that 1,000 is 10 times the size of 100; apply this to identify and work out how many 100s there are in other four-digit multiples of 100.	Solve multiplication problems that involve a scaling structure, such as '10 times as long'.
Recognise the place value of each digit in <i>three</i> -digit numbers, and compose and decompose <i>three</i> -digit numbers using standard and non-standard partitioning.	4NPV-2 Recognise the place value of each digit in <i>four</i> -digit numbers, and compose and decompose <i>four</i> -digit numbers using standard and non-standard partitioning.	Compare and order numbers. Add and subtract using mental and formal written methods.
Reason about the location of any <i>three</i> -digit number in the linear number system, including identifying the previous and next multiple of 10 and 100.	4NPV-3 Reason about the location of any <i>four</i> -digit number in the linear number system, including identifying the previous and next multiple of 1,000 and 100, and rounding to the nearest of each.	Compare and order numbers. Estimate and approximate to the nearest multiple of 1,000, 100 or 10.
Divide 100 into 2, 4, 5 and 10 equal parts, and read scales/number lines marked in multiples of 100 with 2, 4, 5 and 10 equal parts.	4NPV-4 Divide 1,000 into 2, 4, 5 and 10 equal parts, and read scales/number lines marked in multiples of 1,000 with 2, 4, 5 and 10 equal parts.	Read scales on graphs and measuring instruments.
Recall multiplication and division facts in the 5 and 10, and 2, 4 and 8 multiplication tables, and recognise products in these multiplication tables as multiples of the corresponding number.	4NF-1 Recall multiplication and division facts up to 12×12 , and recognise products in multiplication tables as multiples of the corresponding number.	Use multiplication facts during application of formal written methods. Use division facts during application of formal written methods.

Year 3 conceptual prerequisite	Year 4 ready-to-progress criteria	Future applications
<p>Use known division facts to solve division problems.</p> <p>Calculate small differences, for example:</p> $74 - 72 = 2$	<p>4NF-2 Solve division problems, with two-digit dividends and one-digit divisors, that involve remainders, for example:</p> $74 \div 9 = 8 \text{ r } 2$ <p>and interpret remainders appropriately according to the context.</p>	<p>Correctly represent and interpret remainders when using short and long division.</p>
<p>Apply place-value knowledge to known additive and multiplicative number facts (scaling facts by 10), for example:</p> $80 + 60 = 140$ $140 - 60 = 80$ $30 \times 4 = 120$ $120 \div 4 = 30$	<p>4NF-3 Apply place-value knowledge to known additive and multiplicative number facts (scaling facts by 100), for example:</p> $8 + 6 = 14 \text{ and } 14 - 6 = 8$ <p>so</p> $800 + 600 = 1,400$ $1,400 - 600 = 800$ $3 \times 4 = 12 \text{ and } 12 \div 4 = 3$ <p>so</p> $300 \times 4 = 1,200$ $1,200 \div 4 = 300$	<p>Apply place-value knowledge to known additive and multiplicative number facts, extending to a whole number of larger powers of ten and powers of ten smaller than one, for example:</p> $800,000 + 600,000 = 1,400,000$ $1,400,000 - 600,000 = 800,000$ $0.03 \times 4 = 0.12$ $0.12 \div 4 = 0.03$
<p>Multiply two-digit numbers by 10, and divide three-digit multiples of 10 by 10.</p>	<p>4MD-1 Multiply and divide whole numbers by 10 and 100 (keeping to whole number quotients); understand this as equivalent to making a number 10 or 100 times the size.</p>	<p>Convert between different metric units of measure.</p> <p>Apply multiplication and division by 10 and 100 to calculations involving decimals, for example:</p> $0.03 \times 100 = 3$ $3 \div 100 = 0.03$
<p>Understand the inverse relationship between multiplication and division.</p> <p>Write and use multiplication table facts with the factors presented in either order.</p>	<p>4MD-2 Manipulate multiplication and division equations, and understand and apply the commutative property of multiplication.</p>	<p>Recognise and apply the structures of multiplication and division to a variety of contexts.</p>
	<p>4MD-3 Understand and apply the distributive property of multiplication.</p>	<p>Recognise when to use and apply the distributive property of multiplication in a variety of contexts.</p>

Year 3 conceptual prerequisite	Year 4 ready-to-progress criteria	Future applications
Reason about the location of fractions less than 1 in the linear number system.	4F-1 Reason about the location of mixed numbers in the linear number system.	Compare and order fractions.
Identify unit and non-unit fractions.	4F-2 Convert mixed numbers to improper fractions and vice versa.	Compare and order fractions. Add and subtract fractions where calculation bridges whole numbers.
Add and subtract fractions with the same denominator, within 1 whole, for example: $\frac{2}{5} + \frac{2}{5} = \frac{4}{5}$	4F-3 Add and subtract improper and mixed fractions with the same denominator, including bridging whole numbers, for example: $\frac{7}{5} + \frac{4}{5} = \frac{11}{5}$ $3\frac{7}{8} - \frac{2}{8} = 3\frac{5}{8}$ $7\frac{2}{5} + \frac{4}{5} = 8\frac{1}{5}$ $8\frac{1}{5} - \frac{4}{5} = 7\frac{2}{5}$	
Draw polygons by joining marked points.	4G-1 Draw polygons, specified by coordinates in the first quadrant, and translate within the first quadrant.	Draw polygons, specified by coordinates in the 4 quadrants.
Measure lines in centimetres and metres. Add more than 2 addends. Recall multiplication table facts.	4G-2 Identify regular polygons, including equilateral triangles and squares, as those in which the side-lengths are equal and the angles are equal. Find the perimeter of regular and irregular polygons.	Draw, compose and decompose shapes according to given properties, dimensions, angles or area.
	4G-3 Identify line symmetry in 2D shapes presented in different orientations. Reflect shapes in a line of symmetry and complete a symmetric figure or pattern with respect to a specified line of symmetry.	Draw polygons, specified by coordinates in the 4 quadrants: draw shapes following translation or reflection in the axes.

4NPV–1 Equivalence of 10 hundreds and 1 thousand

Know that 10 hundreds are equivalent to 1 thousand, and that 1,000 is 10 times the size of 100; apply this to identify and work out how many 100s there are in other four-digit multiples of 100.

4NPV–1 Teaching guidance

4NPV–1 follows on from what children learnt in year 3 about the relationship between the units of 10 and 100 (see **3NPV–1**).

Pupils need to experience:

- what 1,000 items looks like
- making a unit of 1 thousand out of 10 units of 100, for example using 10 bundles of 100 straws to make 1,000, or using ten 100-value place-value counters



Figure 1: ten 100-value place-value counters in a tens frame

Language focus

“10 hundreds is equal to 1 thousand.”

Pupils must then be able to work out how many hundreds there are in other four-digit multiples of 100.



Figure 2: eighteen 100-value place-value counters in 2 tens frames

Language focus

“18 hundreds is equal to 10 hundreds and 8 more hundreds.”

“10 hundreds is equal to 1,000.”

“So 18 hundreds is equal to 1,000 and 8 more hundreds, which is 1,800.”

The reasoning here can be described as grouping or repeated addition – pupils group or add 10 hundreds to make 1,000, then add another group of 8 hundreds.

Pupils need to be able to apply this reasoning to measures contexts, as shown in the [4NPV-1](#) below. It is important for pupils to understand that there are hundreds within this new unit of a thousand, in different contexts.

Pupils should be able to explain that numbers such as 1,800 and 3,000 are multiples of 100, because they are each equal to a whole number of hundreds. They should be able to identify multiples of 100 based on the fact that they have zeros in both the tens and ones places.

As well as understanding 1,000 and other four-digit multiples of 100 in terms of grouping and repeated addition, pupils should be able to describe these numbers in terms of scaling by 10.

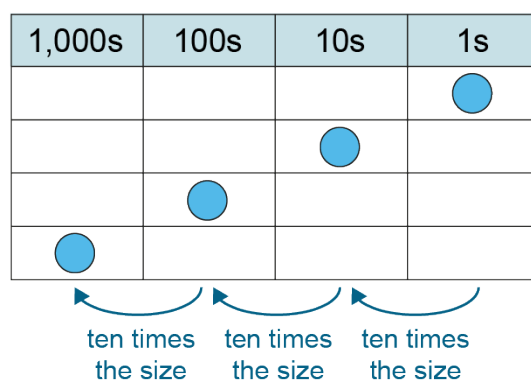

Figure 3: place-value chart illustrating the scaling relationship between ones, tens, hundreds and thousands

Language focus

“1000 is 10 times the size of 100.”

“1,800 is 10 times the size of 180.”

Making connections

Learning to identify the number of hundreds in four-digit multiples of 100 should be connected to pupils' understanding of multiplication and the grouping structure of division (**2MD-1**). Pupils should, for example, be able to represent 1,800 as 18 hundreds using the multiplication equations $1,800 = 18 \times 100$ or $1,800 = 100 \times 18$, and be able to write the corresponding division equations $1,800 \div 100 = 18$ and $1,800 \div 18 = 100$. Criterion **4MD-1** requires pupils to interpret the multiplication equations in terms of the scaling structure of multiplication, for example 1,800 is 100 times the size of 18.

4NPV-1 Example assessment questions

1. How many 100g servings of rice are there in a 2,500g bag?
2. One large desk costs a school £100. How much will 14 large desks cost?
3. My school field is 100m long. How many times do I have to run its length to run 3km?
4. My cup contains 100 ml of fizzy drink. The bottle contains 10 times as much. How many millilitres are there in the bottle?
5. A rhino mother weighs about 1,000kg. She weighs about 10 times as much as her baby. What is the approximate weight of the baby rhino?
6. Circle the lengths that could be made using 1 metre (100cm) sticks.
3,100cm 8,000cm 1,005cm 6,600cm 7,090cm 1,000cm

4NPV–2 Place value in four-digit numbers

Recognise the place value of each digit in *four*-digit numbers, and compose and decompose *four*-digit numbers using standard and non-standard partitioning.

4NPV–2 Teaching guidance

Pupils should be able to identify the place value of each digit in a four-digit number. They must be able to combine units of ones, tens, hundreds and thousands to compose four-digit numbers, and partition four-digit numbers into these units. Pupils need to experience variation in the order of presentation of the units, so that they understand that $40 + 300 + 2 + 5000$ is equal to 5,342, not 4,325.

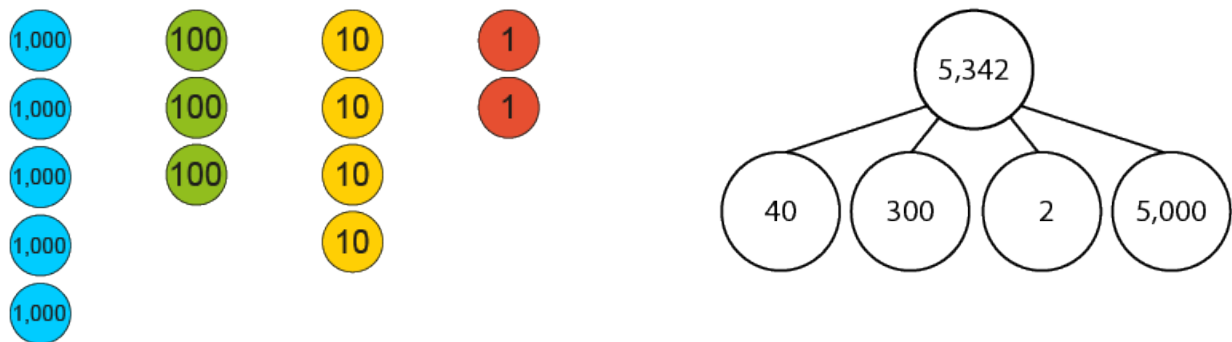

Figure 4: 2 representations of the place-value composition of 5,342

Pupils also need to solve problems relating to subtraction of any single place-value part from the whole number, for example:

$$5,342 - 300 = \square$$

$$5,342 - \square = 5,302$$

As well as being able to partition numbers in the 'standard' way (into individual place-value units), pupils must also be able to partition numbers in 'non-standard' ways, and carry out related addition and subtraction calculations, for example:

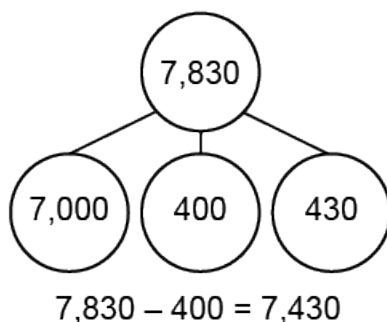

Figure 5: partitioning 7,830 into 7,430 and 400

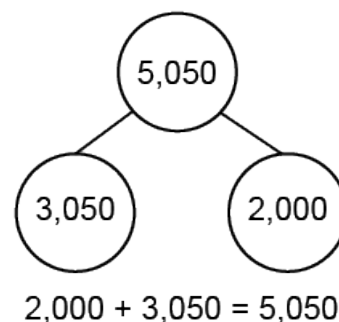

Figure 6: partitioning 5,050 into 2,000 and 3,050

4NPV–2 Example assessment questions

1. Complete the calculations.

$90 + 7 + 6,000 + 400 = \boxed{}$

$4,382 - 300 = \boxed{}$

$900 + 70 + 600 + 4 = \boxed{}$

$4,382 - 80 = \boxed{}$

$9 + 7,000 + 60 + 400 = \boxed{}$

$4,382 - 2 = \boxed{}$

$9,000 + 700 + 6 + 40 = \boxed{}$

$4,382 - 4,000 = \boxed{}$

$8,451 = 5,000 + \boxed{}$

$300 + 5,614 = \boxed{}$

$9,575 - 50 = \boxed{}$

$6,140 = 5,000 + \boxed{} + 40$

$2,000 + 1,430 + 50 = \boxed{}$

2. A football stadium can hold 6,430 people. So far 4,000 tickets have been sold for a match. How many tickets are left?
3. On a field trip, the children need to walk 4,200m. So far they have walked 3km. How much further do they have to walk?
4. Mr. Davis has 2 cats. One cat weighs 4,200g. The other cat weighs 3,050g. Their basket weighs 2kg. How much does the basket weigh with both cats inside it?

4NPV–3 Four-digit numbers in the linear number system

Reason about the location of any *four*-digit number in the linear number system, including identifying the previous and next multiple of 1,000 and 100, and rounding to the nearest of each.

4NPV–3 Teaching guidance

Pupils need to be able to identify or place four-digit numbers on marked number lines with a variety of scales. Pupils should also be able to estimate the value or position of four-digit numbers on unmarked numbers lines, using appropriate proportional reasoning. Pupils should apply this skill to taking approximate readings of scales in measures and statistics contexts, as shown in the Example assessment questions below. For more detail on identifying, placing and estimating positions of numbers on number lines, see year 2, **2NPV–2**.

Pupils must also be able to identify which pair of multiples of 1000 or 100 a given four-digit number is between. To begin with, pupils can use a number line for support. In this example, for the number 8,681, pupils must identify the previous and next multiples of 1,000 and 100.

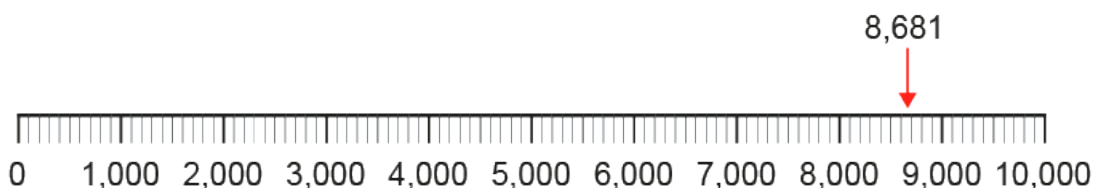

Figure 7: using a number line to identify the previous and next multiple of 1,000

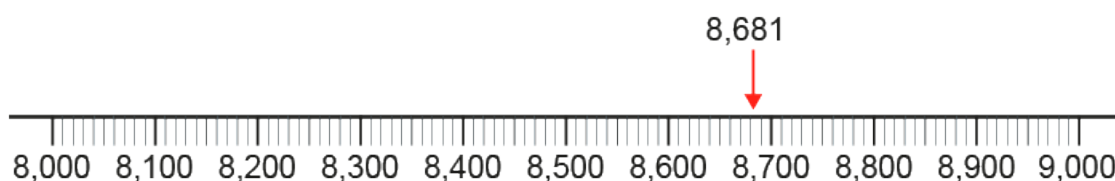

Figure 8: using a number line to identify the previous and next multiple of 100

Language focus

“The previous multiple of 1,000 is 8,000. The next multiple of 1,000 is 9,000.”

“The previous multiple of 100 is 8,600. The next multiple of 100 is 8,700.”

Pupils need to be able to identify previous and next multiples of 1000 or 100 without the support of a number line.

Pupils should then learn to round a given four-digit number to the nearest multiple of 1,000 by identifying the nearest of the pair of multiples of 1,000 that the number is between. Similarly, pupils should learn to round to the nearest multiple of 100. They should understand that they need to examine the digit in the place to the right of the multiple they are rounding to, for example when rounding to the nearest multiple of 1,000 pupils must examine the digit in the hundreds place. Again, pupils can initially use number lines for support, but should be able to round without that support by the end of year 4.



Figure 9: identifying the nearest multiple of 1,000 with a number line for support

Language focus

“The closest multiple of 1,000 is 9,000.”

“8,681 rounded to the nearest thousand is 9,000.”

Finally, pupils should also be able to count forwards and backwards from any four-digit number in steps of 1, 10 or 100. Pay particular attention to counting over ‘boundaries’, for example:

- 2,100, 2,000, 1,900
- 2,385, 2,395, 2,405

Making connections

Here, pupils must apply their knowledge that 10 hundreds is equal to 1 thousand (see [4NPV-1](#)) to understand that each interval of 1,000 on a number line or scale is made up of 10 intervals of 100. This also links to [4NPV-4](#) in which pupils need to be able to read scales divided into 2, 4, 5 and 10 equal parts. However, for the current criterion pupils are not expected to make precise placements, but instead approximate using proportional reasoning.

4NPV-3 Example assessment questions

1.

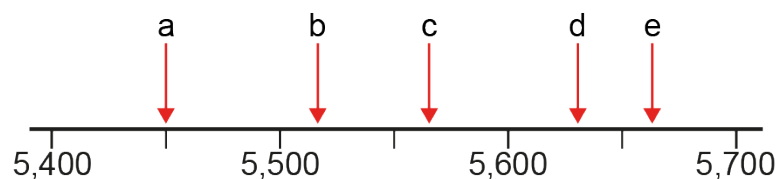

- a. Which 2 numbers round to 5,600 when rounded to the nearest hundred?
- b. Round each number to the nearest thousand.
- c. Estimate the value of each number.

2.

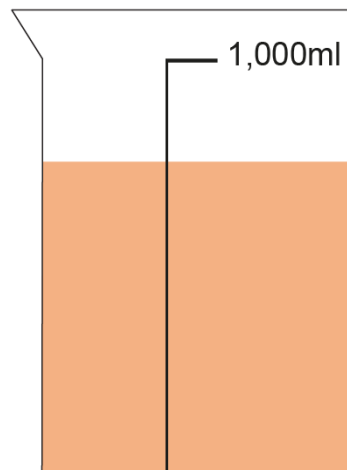

- a. Estimate how much liquid is in the beaker.
- b. Estimate how much liquid needs to be added to make 1 litre.

3. Estimate and mark the position of 600g on this scale.



4. The bar chart shows the number of red and blue cars that passed a school in one day.

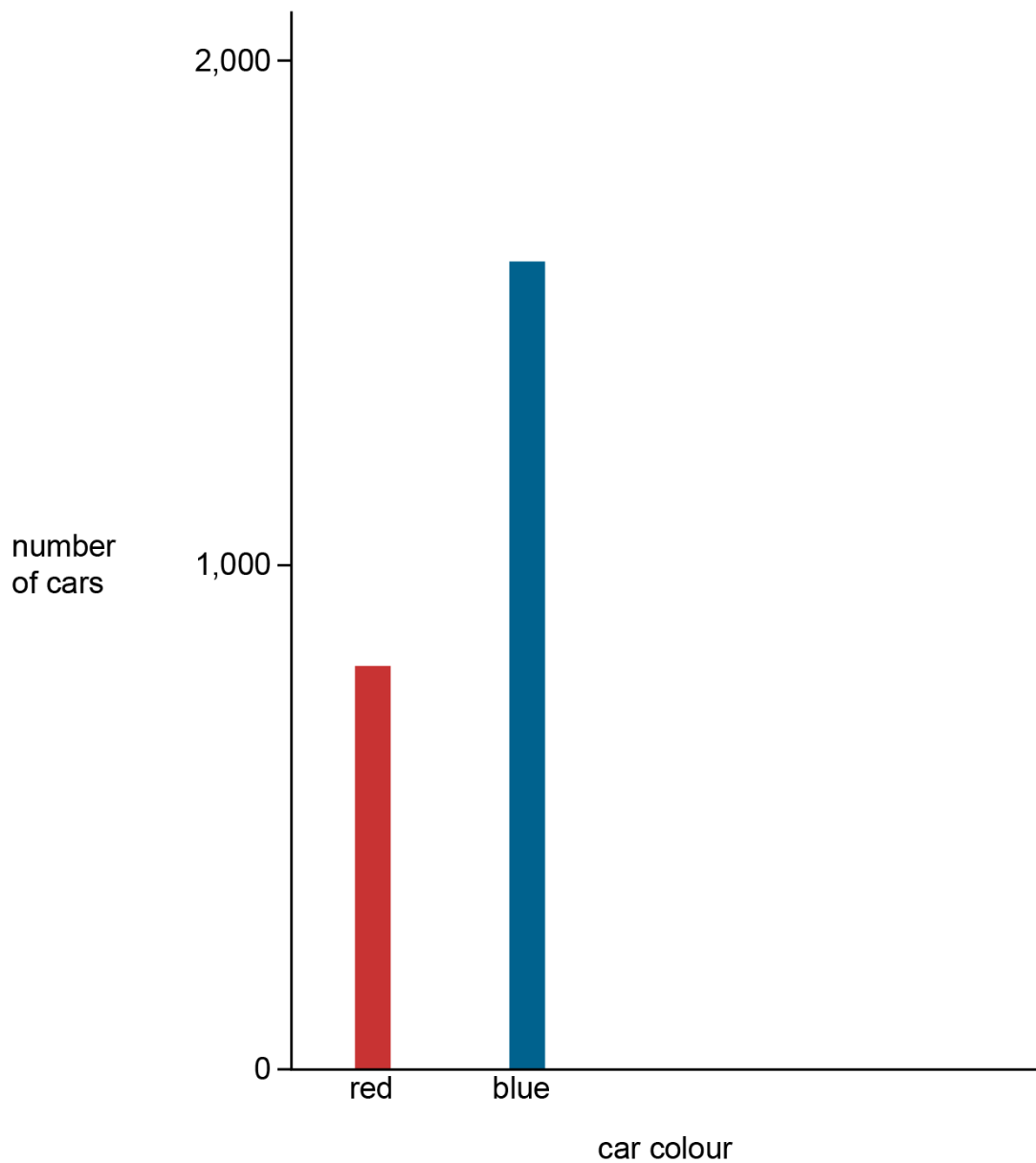

- Estimate the number of red and blue cars that passed the school on this day.
- Estimate the number of blue cars that passed the school on this day.
- Add the following data for other coloured cars to the bar chart.

	Yellow	Black	White
Number of cars	100	1,050	1,995

5. Fill in the missing numbers.

600	700		900		1,100		1,300
			5,001	5,002	5,003		
3,650			3,950			4,250	4,350
	1,075	1,085	1,095				

4NPV–4 Reading scales with 2, 4, 5 or 10 intervals

Divide 1,000 into 2, 4, 5 and 10 equal parts, and read scales/number lines marked in multiples of 1,000 with 2, 4, 5 and 10 equal parts.

4NPV–4 Teaching guidance

By the end of year 4, pupils must be able to divide 1,000 into 2, 4, 5 or 10 equal parts. This is important because these are the intervals commonly found on measuring instruments and graph scales.

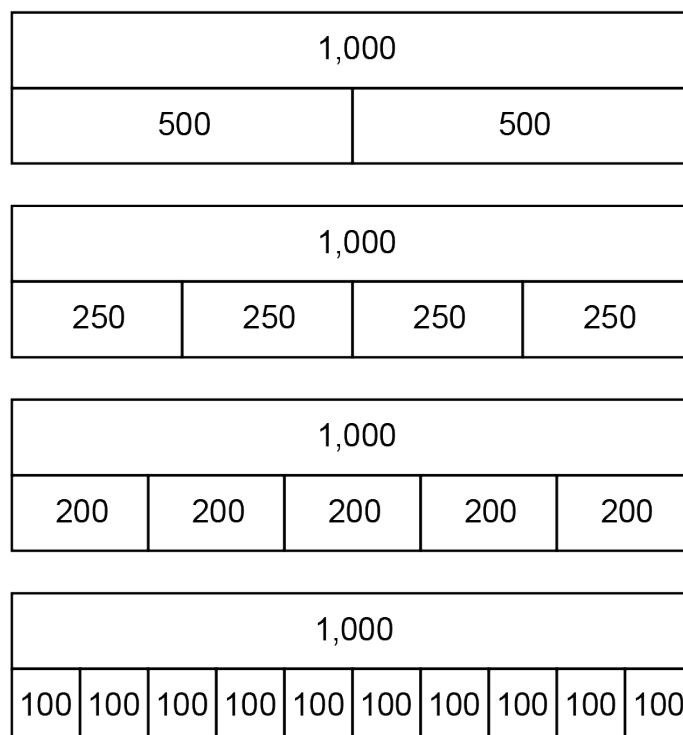

Figure 10: bar models showing 1,000 partitioned into 2, 4, 5 and 10 equal parts

Pupils should practise counting in multiples of 100, 200, 250, and 500 from 0, or from any multiple of these numbers, both forwards and backwards. This is an important step in becoming fluent with these number patterns. Pupils will have been practising counting in multiples of 1, 2 and 5 since year 1, and this supports counting in units of 100, 200 and

500. Pupils typically find counting in multiples of 250 the most challenging, because they only started to encounter this pattern in year 3, when counting in multiples of 25.

Language focus

“Twenty-five, fifty, seventy-five, one hundred” needs to be a fluent spoken language pattern. Fluency in this language pattern provides the basis to count in multiples of 250.

Pupils should be able to apply this skip counting, beyond 1,000, to solve contextual multiplication and division measures problems, as shown in the [4NPV-4](#) below (questions 5 and 7). Pupils should also be able to write and solve multiplication and division equations related to multiples of 100, 200, 250 and 500 up to 1,000.

Pupils need to be able to solve addition and subtraction problems based on partitioning 1,000 into multiples of 100, 200 and 500 based on known number bonds to 10. Pupils should also have automatic recall of the fact that 250 and 750 are bonds to 1,000. They should be able to immediately answer a question such as “I have 1 litre of water and pour out 250ml. How much is left?”

Making connections

[4MD-2](#) requires pupils to manipulate multiplication and division equations. They should therefore be able to write and manipulate multiplication and division equations related to the composition of 1,000 as discussed here.

Dividing 1,000 into 10 equal parts is also assessed as part of [4NPV-1](#).

Reading scales builds on number line knowledge from [4NPV-3](#). Conversely, experience of working with scales with 2, 4, 5 or 10 divisions in this criterion improves pupils’ estimating skills when working with unmarked number lines and scales as described in [4NPV-3](#).

4NPV-4 Example assessment questions

1. Fill in the missing numbers.

3,000		4,000	4,500	5,000	
	2,400			3,000	3,200
1,500		2,000			2,750

2. What is the reading on each of these scales?

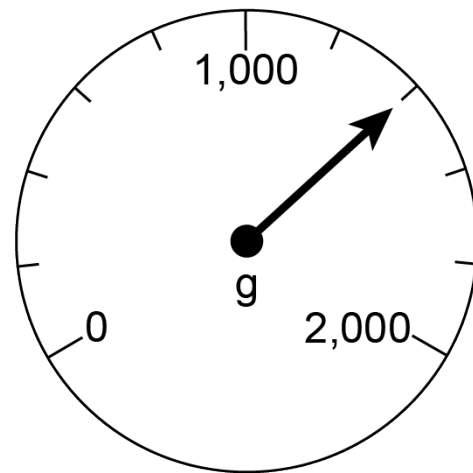
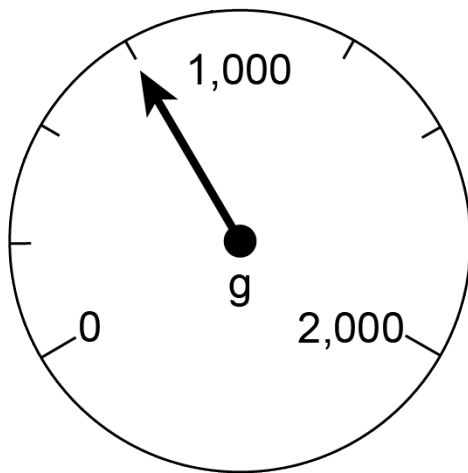

3. The beaker contains 1 litre of water.

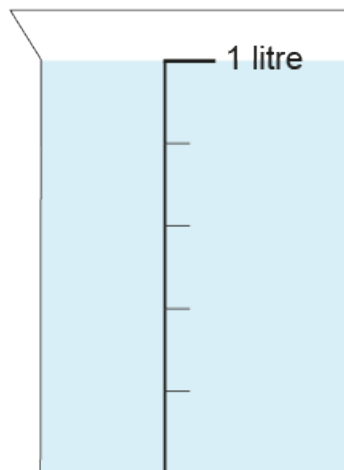

If I pour out 600ml, how much is left? Mark the new water level on the picture.

- A motorway repair team can build 250m of motorway barrier in 1 day. In 5 working days, how many metres of motorway barrier can they build?
- How many 500ml bottles can I fill from a 3 litre container of water?

6. The pictogram shows how many cans a class recycled in 2020.

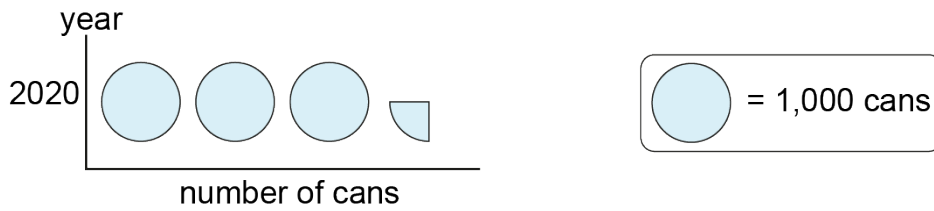

How many cans did the class recycle in 2020?

- 7. 1kg of strawberries is shared equally between 5 people. How many grams of strawberries do they each get?
- 8. I have already swum 750m. How much further do I need to go to swim 2km?
- 9. Fill in the missing parts, and write as many different equations as you can think of to describe the structure.

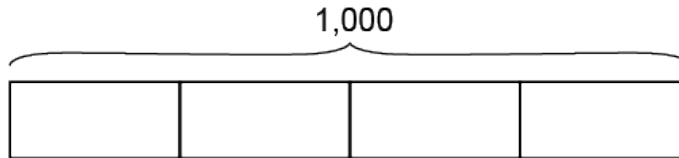

10. The bar charts show the number of red and blue cars that passed 3 different schools on a given day. How many red and blue cars passed each school?

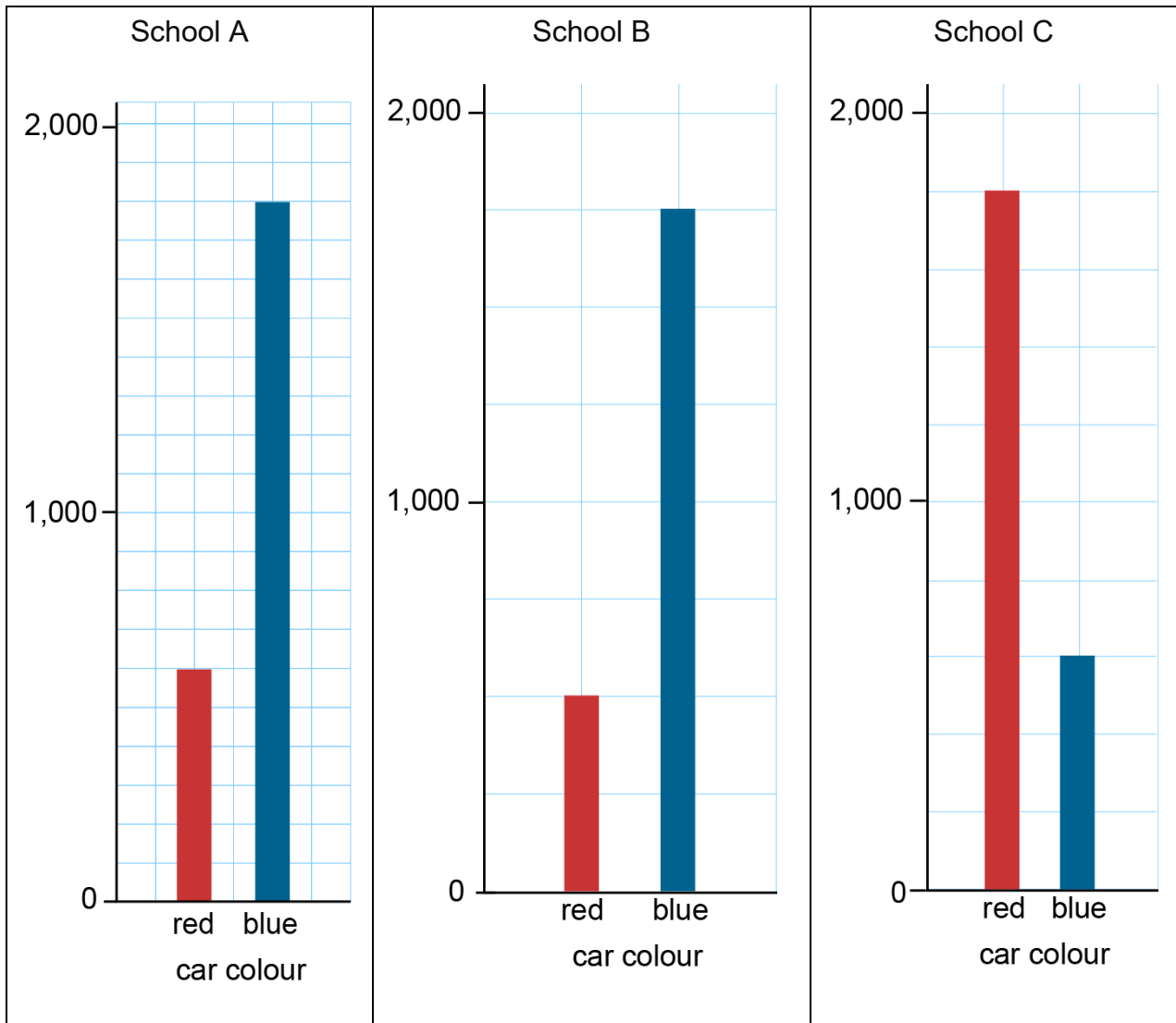

11. Fill in the missing numbers.

$$1,000 \div 4 = \boxed{}$$

$$\boxed{} \times 200 = 1,000$$

$$1,000 \div 500 = \boxed{}$$

$$250 + \boxed{} = 1,000$$

4NF–1 Recall of multiplication tables

Recall multiplication and division facts up to 12×12 , and recognise products in multiplication tables as multiples of the corresponding number.

4NF–1 Teaching guidance

The national curriculum requires pupils to recall multiplication table facts up to 12×12 , and this is assessed in the multiplication tables check. For pupils who do not have automatic recall of all of the facts by the time of the check, fluency in facts up to 9×9 should be prioritised in the remaining part of year 4. The facts to 9×9 are particularly important for progression to year 5, because they are required for formal written multiplication and division.

The 36 multiplication facts that are required for formal written multiplication are as follows.

2×2							
3×2	3×3						
4×2	4×3	4×4					
5×2	5×3	5×4	5×5				
6×2	6×3	6×4	6×5	6×6			
7×2	7×3	7×4	7×5	7×6	7×7		
8×2	8×3	8×4	8×5	8×6	8×7	8×8	
9×2	9×3	9×4	9×5	9×6	9×7	9×8	9×9

During application of formal written multiplication, pupils may also need to multiply a one-digit number by 1. Multiplication of the numbers 1 to 9 by 1 are not listed here because these calculations do not need to be recalled in the same way.

While pupils are learning the individual multiplication tables, they should also learn that:

- the factors can be written in either order and the product remains the same (for example, we can write $3 \times 4 = 12$ or $4 \times 3 = 12$ to represent the third fact in the 4 multiplication table)
- the products within each multiplication table are multiples of the corresponding number, and be able to recognise multiples (for example, pupils should recognise, 64 is a multiple of 8, but that 68 is not)
- adjacent multiples in, for example, the 8 multiplication table, have a difference of 8

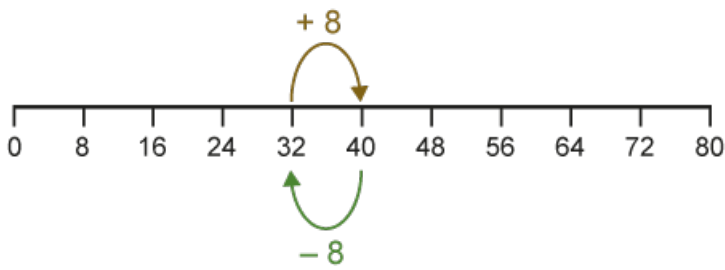

×	1	2	3	4	5	6	7	8
1	●	●	●	●	●	●	●	●
2	●	●	●	●	●	●	●	●
3	●	●	●	●	●	●	●	●
4	●	●	●	●	●	●	●	●
5	●	●	●	●	●	●	●	●

Figure 11: number line and array showing that adjacent multiples of 8 (32 and 40) have a difference of 8

Language focus

When pupils commit multiplication table facts to memory, they do so using a verbal sound pattern to associate the 3 relevant numbers, for example, “nine sevens are sixty-three”. It is important to provide opportunities for pupils to verbalise each multiplication fact as part of the process of developing fluency.

It is useful for pupils to learn the multiplication tables in the following order/groups:

1. 10 then 5 multiplication tables
1. 2, 4 and 8 multiplication tables one after the other
2. 3, 6, and 9 multiplication tables one after the other
3. 7 multiplication table
4. 11 and 12 multiplication tables

The connections and patterns will help pupils to develop fluency and understanding.

Pupils must also be able to apply their automatic recall of multiplication table facts to solve division problems, for example, solving $28 \div 7$, by recalling that $28 = 4 \times 7$.

You can find out more about developing automatic recall of multiplication tables here in the calculation and fluency section: [4NF-1](#)

Making connections

Solving division problems with remainders ([4NF-2](#)), relies on automatic recall of multiplication facts.

Criterion [4MD-2](#) involves linking individual multiplication facts to related multiplication and division facts. Once pupils have automatic recall of the multiplication table facts, they then have access to a whole set of related facts. For example, if pupils know that $3 \times 4 = 12$, they also know that $4 \times 3 = 12$, $12 \div 3 = 4$ and $12 \div 4 = 3$.

Converting mixed numbers to improper fractions ([4F-2](#)), also relies on automatic recall of multiplication facts. For example, converting $3\frac{1}{6}$ to an improper fraction involves calculating 3 times 6 sixths plus 1 more sixth, so requires knowledge of the multiplication fact $3 \times 6 = 18$.

Efficiently calculating the perimeter of a regular polygon ([4G-2](#)), or finding the side-length of a regular polygon, given the perimeter, depends on recall of multiplication and division facts.

4NF-1 Example assessment questions

1. A regular hexagon has sides of 7cm. What is its perimeter?

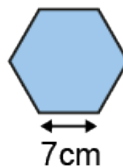

2. A regular octagon has a perimeter of 72cm. What is the length of each of the sides?

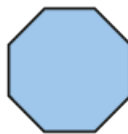

3. It takes Latoya 8 minutes to walk to school. It takes Tatsuo 3 times as long. How long does it take Tatsuo to walk to school?
4. An egg box contains 6 eggs. I need 54 eggs. How many boxes should I buy?
5. 8 children spend a day washing cars and earn £40 altogether. If they share the money equally how much do they each get?
6. Circle the numbers that are multiples of 3.

16 18 23 9 24

Assessment guidance: The multiplication tables check will assess pupils' fluency. Once pupils can automatically recall multiplication facts, they should be able to apply their knowledge to questions like those shown here.

4NF–2 Division problems with remainders

Solve division problems, with two-digit dividends and one-digit divisors, that involve remainders, for example:

$$74 \div 9 = 8 \text{ r } 2$$

and interpret remainders appropriately according to the context.

4NF–2 Teaching guidance

Pupils should recognise that a remainder arises when there is something 'left over' in a division calculation. Pupils should recognise and understand why remainders only occur when the dividend is not a multiple of the divisor. This can be achieved by discussing the patterns seen when the dividend is incrementally increased by 1 while the divisor is kept the same.

Total number of apples (dividend)	Number of apples in each tray (divisor)	Number of trays (quotient)	Number of apples left over (remainder)	Equation
12	4	3	0	$12 \div 4 = 3$
13	4	3	1	$13 \div 4 = 3 \text{ r } 1$
14	4	3	2	$14 \div 4 = 3 \text{ r } 2$
15	4	3	3	$15 \div 4 = 3 \text{ r } 3$
16	4	4	0	$16 \div 4 = 4$
17	4	4	1	$17 \div 4 = 4 \text{ r } 1$
18	4	4	2	$18 \div 4 = 4 \text{ r } 2$
19	4	4	3	$19 \div 4 = 4 \text{ r } 3$
20	4	5	0	$20 \div 4 = 5$

A common mistake made by pupils is not making the maximum number of groups possible, for example:

$$17 \div 4 = 3 \text{ r } 5 \quad (\text{incorrect})$$

The table above can be used to help pupils recognise and understand that the remainder is always smaller than the divisor. Note that when pupils use the short division algorithm in year 5, if they ‘carry over’ remainders that are larger than the divisor, the algorithm will not work.

Language focus

“If the dividend is a multiple of the divisor there is no remainder.”

“If the dividend is not a multiple of the divisor, there is a remainder.”

“The remainder is always less than the divisor.”

Once pupils can correctly perform division calculations that involve remainders, they need to recognise that, when solving contextual division problems, the answer to the division calculation must be interpreted carefully to determine how to make sense of the remainder. The answer to the calculation is not always the answer to the contextual problem.

Consider the following context: Four scouts can fit in each tent. How many tents will be needed for thirty scouts?

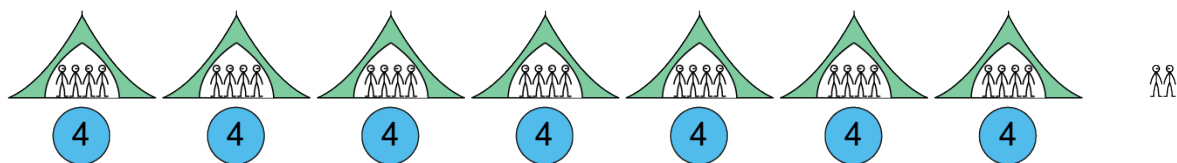

Figure 12: pictorial representation and counters: with 30 scouts and 4 per tent, 7 tents are insufficient

$$30 \div 4 = 7 \text{ r } 2$$

Pupils may simply say that “7 remainder 2 tents are needed”, but this does not answer the question. Pupils should identify what each number in the equation represents to help them correctly interpret the result of the calculation in context.

Language focus

“The 30 represents the total number of scouts.”

“The 4 represents the number of scouts in each tent.”

“The 7 represents the number of full tents.”

“The 2 represents the number of scouts left over.”

“We need another tent for the 2 left-over scouts. 8 tents are needed.”

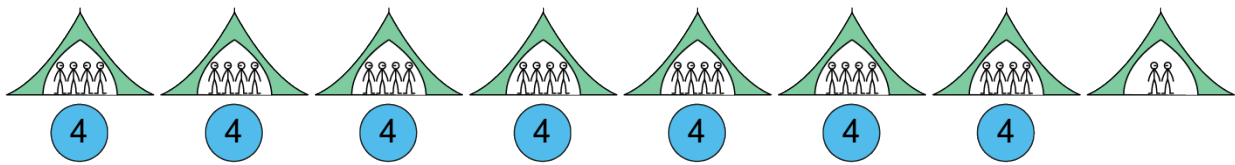

Figure 13: pictorial representation and counters: with 30 scouts and 4 per tent, 7 tents are insufficient

Making connections

Pupils must have automatic recall of multiplication facts and related division facts, and be able to recognise multiples ([4NF-1](#)) before they can solve division problems with remainders. For example, to calculate $55 \div 7$, pupils need to be able to identify the largest multiple of 7 that is less than 55 (in this case 49). They must then recall how many sevens there are in 49, and calculate the remainder.

Converting improper fractions to mixed numbers ([4F-2](#)) relies on solving division problems with remainders. For example, converting $\frac{19}{6}$ to a mixed number depends on the calculation $19 \div 6 = 3 \text{ r } 1$.

4NF-2 Example assessment questions

1. Which of these division calculations have the answer of 3 r 2?

$$23 \div 7$$

$$17 \div 5$$

$$32 \div 6$$

$$7 \div 2$$

$$14 \div 4$$

$$30 \div 8$$

2. I have 60 metres of bunting for the school fair. What length of bunting will be left over if I cut it into lengths of 8 metres?

- It takes 7 minutes to make a pom-pom. How many complete pom-poms can Malik make in 30 minutes?
- 23 apples are shared equally between 4 children. How many whole apples does each child get?
- Ruby writes:
 $37 \div 5 = 6 \text{ r } 7$
 Explain what mistake Ruby has made, and write the correct answer.
- Decide whether each calculation has a remainder or not. Explain how you can do this without doing each calculation?

	Has a remainder? (Yes or No)
$48 \div 7$	
$48 \div 8$	
$48 \div 9$	
$56 \div 7$	
$56 \div 8$	
$56 \div 9$	

4NF–3 Scaling number facts by 100

Apply place-value knowledge to known additive and multiplicative number facts (scaling facts by 100), for example:

$$8 + 6 = 14 \text{ and } 14 - 6 = 8$$

so

$$800 + 600 = 1,400 \text{ and } 1,400 - 600 = 800$$

$$3 \times 4 = 12 \text{ and } 12 \div 4 = 3$$

so

$$300 \times 4 = 1,200 \text{ and } 1,200 \div 4 = 300$$

4NF–3 Teaching guidance

Pupils should begin year 4 with automatic recall of addition and subtraction facts within 20 (**3NF–1**). By the end of year 4, pupils should be able to recall all multiplication table facts and related division facts. To be ready to progress to year 5, pupils must also be able to combine these facts with unitising in hundreds, including:

- scaling known additive facts within 10, for example, $900 - 600 = 300$

- scaling known additive facts that bridge 10, for example, $800 + 600 = 1,400$
- scaling known multiplication tables facts, for example, $300 \times 4 = 1,200$
- scaling division facts derived from multiplication tables, for example, $1,200 \div 4 = 300$

For calculations such as $800 + 600 = 1,400$, pupils can begin by using tens frames and counters as they did for calculation across 10 (**2AS-1**) and across 100 (**3NF-3**), but now using 100-value counters.

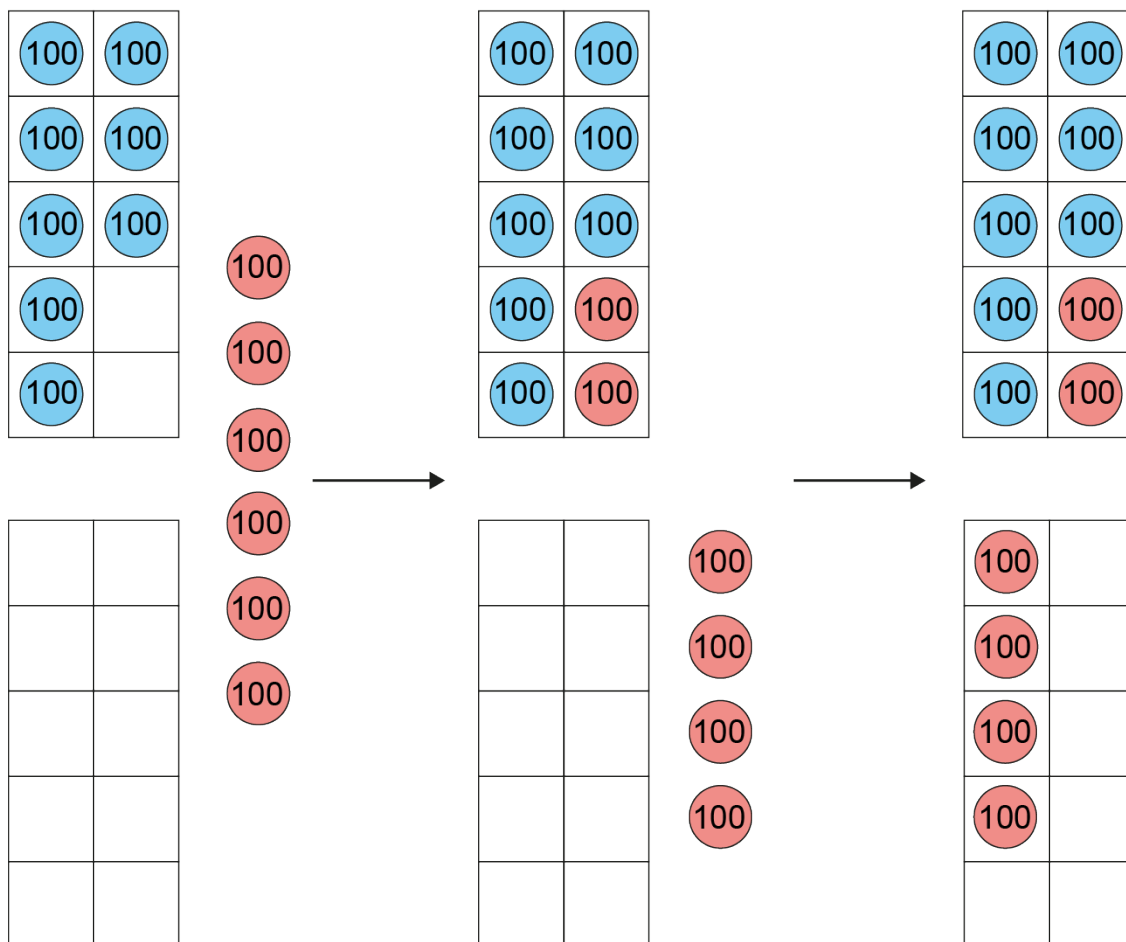

Figure 14: tens frames with 100-value counters showing $800 + 600 = 1,400$

$$8 + 6 = 14$$

$$800 + 600 = 1,400$$

$$14 - 6 = 8$$

$$1,400 - 600 = 800$$

$$14 - 8 = 6$$

$$1,400 - 800 = 600$$

Similarly, pupils can use 100-value counters to understand how a known multiplicative fact, such as $3 \times 5 = 15$, relates to a scaled calculation, such as $300 \times 5 = 1,500$. Pupils should be able reason in terms of unitising in hundreds, or in terms of scaling a factor by 100.



Figure 15: 3-by-5 array of 100-value place-value counters

$$3 \times 5 = 15$$
$$3 \times 500 = 1,500$$

$$3 \times 5 = 15$$
$$300 \times 5 = 1,500$$

Language focus

“3 times 5 is equal to 15.”

“3 times 5 hundreds is equal to 15 hundreds.”

“15 hundreds is equal to 1,500.”

Language focus

“3 times 5 is equal to 15.”

“3 hundreds times 5 is equal to 15 hundreds.”

“15 hundreds is equal to 1,500.”

Language focus

“If I multiply one factor by 100, I must multiply the product by 100.”

Pupils must be able to make similar connections for known division facts.

$$15 \div 3 = 5$$

$$1,500 \div 300 = 5$$

$$1,500 \div 3 = 500$$

Language focus

“If I multiply the dividend by 100 and the divisor by 100, the quotient remains the same.”

“If I multiply the dividend by 100 and keep the divisor the same, I must multiply the quotient by 100.”

It is important for pupils to understand all of the calculations in this criterion in terms of working with units of 100, or scaling by 100.

You can find out more about fluency and recording for these calculations here in the calculation and fluency section: [Number, place value and number facts: 4NPV–2 and 4NF–3](#)

Making connections

This criterion builds on pupils' additive fluency and also on:

- [4NPV–1](#) , where pupils need to be able to work out how many hundreds there are in any four-digit multiple of 100
- [4NF–1](#) , where pupils develop fluency in multiplication and division facts

Meeting this criterion also requires pupils to be able to fluently multiply whole numbers by 100 ([4MD–1](#)).

4NF–3 Example assessment questions

1. I need 1kg of flour to make some bread. I have 800g. How many more grams of flour do I need?
2. A builder can buy bricks in pallets of 600. How many pallets should she buy if she needs 1,800 bricks?
3. Dexter ran round a 400m running track 6 times. How far did he run?
4. I mix 700ml of orange juice and 600ml of lemonade to make a fruit drink for a party. What volume of fruit drink have I made in total?
5. A farmer had 1,200m of fencing to put up round his fields. He put up the same amount of fencing each day, and it took him 6 days to put up all the fencing. How many metres of fencing did he put up each day?
6. Fill in the missing numbers.

$$300 + \square = 1,100$$

$$4,200 \div 600 = \square$$

4MD–1 Multiplying and dividing by 10 and 100

Multiply and divide whole numbers by 10 and 100 (keeping to whole number quotients); understand this as equivalent to making a number 10 or 100 times the size.

4MD–1 Teaching guidance

As well as being able to calculate multiplication and division by 10 and 100, pupils need to start to think about multiplication as scaling, so that they can conceive of dividing by 10 and 100 when there are decimal answers in year 5 (**5NF–2**). If pupils only understand multiplying by 10 or 100 in terms of the repeated addition/grouping structure of multiplication (for example, 23×100 is 100 groups of 23), they will struggle to conceptualise $23 \div 100$. However, if pupils understand 23×100 as ‘23, made one-hundred times the size’, the inverse of this, $23 \div 100$, can be thought of as ‘23 made one-hundredth times the size’. To meet criteria **4MD–1**, pupils should be able to use and understand the language of 10 or 100 times the size, and understand division as the inverse action; in year 5, once pupils have learnt about tenths and hundredths they should apply the language to division by 10 and 100 (1 tenth or 1 hundredth times the size).

Language focus

“23, made 100 times the size, is 2,300.”

“23 multiplied by 100 is equal to 2,300.”

“First we had 23 ones. Now we have 23 hundreds.”

“1,450 is 10 times the size of 145.”

“1,450 divided by 10 is equal to 145.”

“First we had 145 tens. Now we have 145 ones.”

Pupils know that 1,000 is 10 times the size of 100 (**4NPV–1**), and that 100 is 10 times the size of 10 (**3NPV–2**). Pupils should now extend this ‘10 times the size’ relationship to other numbers, beginning with those with 1 significant figure. The Gattegno chart can be used to help pupils see, for example, that 80, made 10 times the size is 800: pupils can move their finger or a counter *up* from 80 to 800. They should connect this action to multiplication by 10, and be able to solve/write the corresponding multiplication calculation ($80 \times 10 = 800$). Similarly, because 80 is 10 times the size of 8, they can solve $80 \div 10 = 8$, moving their finger or a counter *down* from 80 to 8.

1,000	2,000	3,000	4,000	5,000	6,000	7,000	8,000	9,000
100	200	300	400	500	600	700	800	900
10	20	30	40	50	60	70	80	90
1	2	3	4	5	6	7	8	9

$80 \times 10 = 800$ $80 \div 10 = 8$

Figure 16: using the Gattegno chart to multiply and divide by 10

Pupils may also work with place-value charts.

1,000s	100s	10s	1s
			8
	8	0	0

$8 \times 100 = 800$ $800 \div 100 = 8$

Figure 17: using a place-value chart to multiply and divide by 100

Repeated association of the written form (for example, $\times 10$) and the verbal form (“ten times the size”) will help pupils become fluent with the links. Pupils should also be able to relate multiplying by 10 or by 100 with the idea of multiplying a quantity of items – here they can use the verbal form “ten times as many”, for example, “200 pencils is 10 times as many as 20 pencils.”

Both the Gattegno chart and the place-value chart also help pupils to see that multiplying by 100 is equivalent to multiplying by 10, and then multiplying by 10 again (and that dividing by 100 is equivalent to dividing by 10 and dividing by 10 again).

The same representations can be used to extend to numbers with more than one significant digit.

$$13 \times 10 = 130$$

$$130 \div 10 = 13$$

$$130 \times 10 = 1,300$$

$$1,300 \div 10 = 130$$

$$13 \times 100 = 1,300$$

$$1,300 \div 100 = 13$$

Making connections

In **3NPV-2** and **4NPV-1**, respectively, children learnt that 100 is 10 times the size of 10, and 1,000 is 10 times the size of 100. Here they applied this idea to scaling other numbers.

Until **4MD-1**, pupils understood, for example, 23×100 to represent 23 groups of 100. Here pupils must relate the same equation to a completely different structure – the scaling of 23 by 100 (making 23 one hundred times the size). Pupils learn more about how one equation can represent different multiplicative structures in **4MD-2**.

4MD-1 Example assessment questions

1. Fill in the missing numbers.

$$\begin{array}{ccc} & \times 100 & \\ & \rightarrow & \\ \boxed{11} & & \boxed{} \\ & \leftarrow & \\ & \div 100 & \end{array}$$

$$\begin{array}{ccc} & \times 100 & \\ & \rightarrow & \\ \boxed{} & & \boxed{3,500} \\ & \leftarrow & \\ & \div 100 & \end{array}$$

$$\begin{array}{ccc} & \times 10 & \\ & \rightarrow & \\ \boxed{14} & & \boxed{} \\ & \leftarrow & \\ & \div 10 & \end{array}$$

$$\begin{array}{ccc} & \times 10 & \\ & \rightarrow & \\ \boxed{} & & \boxed{250} \\ & \leftarrow & \\ & \div 10 & \end{array}$$

2. Bethany has 15 marbles. Nasir has 100 times as many. How many marbles does Nasir have?
3. Sumaya's walk from her home to school is 130m. Millie's walk is 10 times as far. How far does Millie walk to get to school?
4. Fill in the missing numbers.

$$\boxed{} \times 100 = 600$$

$$1,500 = \boxed{} \times 10$$

$$\boxed{} \div 100 = 8$$

$$1,200 = \boxed{} \div 10$$

4MD–2 Manipulating the multiplicative relationship

Manipulate multiplication and division equations, and understand and apply the commutative property of multiplication.

4MD–2 Teaching guidance

Pupils will begin year 4 with an understanding of some of the individual concepts covered in this criterion, but they need to leave year 4 with a coherent understanding of multiplicative relationships, and how multiplication and division equations relate to the various multiplicative structures.

Pupils need to be able to apply the commutative property of multiplication in 2 different ways. The first can be summarised as ‘1 interpretation, 2 equations’. Here pupils must understand that 2 different equations can correspond to one context, for example, 2 groups of 3 is equal to 6 can be represented by $2 \times 3 = 6$ and by $3 \times 2 = 6$. Spoken language can support this understanding.

Language focus

“2 groups of 3 is equal to 6.”

“3, two times is equal to 6.”

“2 groups of 3 is equal to 3, two times.”

The second way that pupils must understand commutativity, can be summarised as ‘one equation, two interpretations’. Here, pupils must understand that a single equation, such as $2 \times 7 = 14$, can be interpreted in two ways.

Language focus

“2 groups of 7 is equal to 14.”

“7 groups of 2 is equal to 14.”

“2 groups of 7 is equal to 7 groups of 2.”

Pupils should understand that both interpretations correspond to the same total quantity (product).

Language focus

“factor times factor is equal to product”

“The order of the factors does not alter the product.”

An array is an effective way to illustrate this.

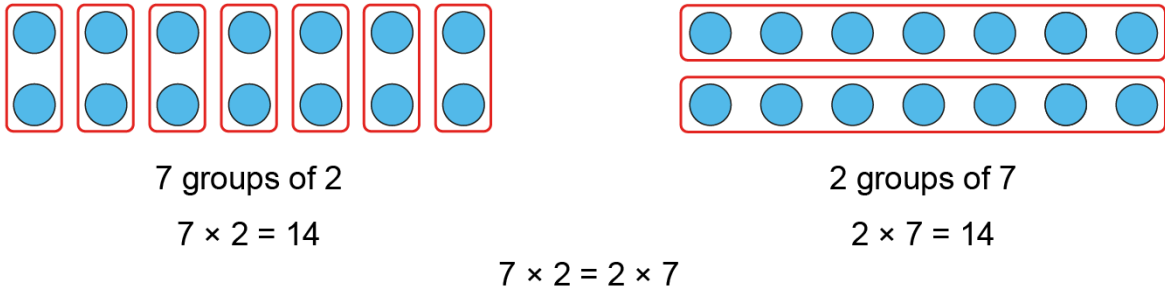

Figure 18: using an array to show that 7 groups of 2 and 2 groups of 7 both correspond to the same total quantity

Pupils must be able to describe what each number in the equation represents for the 2 different interpretations, in context.

$$7 \times 2 = 14$$

$$2 \times 7 = 14$$

Interpretation 1

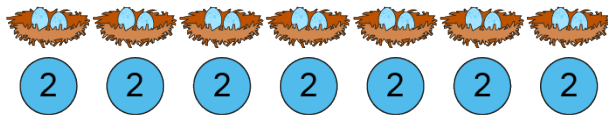

Interpretation 2

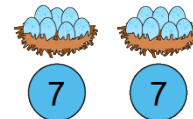

Figure 19: 7 groups of 2 – 7 nests of 2 eggs and seven 2-value counters

Figure 20: 2 groups of 7 – 2 nests of 7 eggs and two 7-value counters

Language focus

“The 2 represents number of eggs in each nest/group”.

“The 7 represents the number of nests/groups.”

“The 14 represents the total number of eggs/product.”

Language focus

“The 2 represents the number of nests/groups.”

“The 7 represents the number of eggs in each nest/group.”

“The 14 represents the total number of eggs/product.”

Pupils should be able to bring together these ideas to understand that either of a pair of multiplication equations can have two different interpretations.

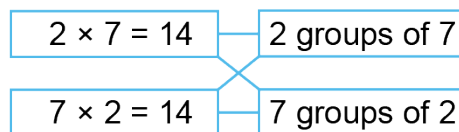

Figure 21: schematic diagram summarising the commutative property of multiplication and the different grouping interpretations

Pupils must understand that, because division is the inverse of multiplication, any multiplication equation can be rearranged to give division equations. The value of the product in the multiplication equation becomes the value of the dividend in the corresponding division equations.

$$2 \times 7 = 14$$

$$7 \times 2 = 14$$

$$14 \div 2 = 7$$

$$14 \div 7 = 2$$

This means that the commutative property of multiplication has a related property for division.

Language focus

“If we swap the values of the divisor and quotient, the dividend remains the same.”

As with multiplication, any division equation can be interpreted in two different ways, and these correspond to quotitive and partitive division.

$$14 \div 7 = 2$$

Partitive division

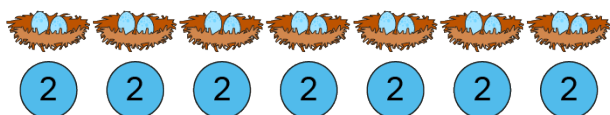

Figure 121: 7 groups of 2 – 7 nests of 2 eggs and seven 2-value counters

Language focus

“14 shared between 7 is equal to 2.”

“The 14 represents the total number of eggs.”

“The 7 represents the number of nests/shares.”

“The 2 represents the number of eggs in each nest/share.”

Quotitive division

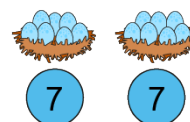

Figure 122: 2 groups of 7 – 2 nests of 7 eggs and two 7-value counters

Language focus

“14 divided into groups of 7 is equal to 2.”

“The 14 represents the total number of eggs.”

“The 7 represents the number of eggs in each nest/group.”

“The 2 represents the number of nests/groups.”

Pupils need to be able to fluently move between the different equations in a set, and understand how one known fact (such as $7 \times 2 = 14$) allows them to solve 4 different calculations each with two possible interpretations.

You can find out more about fluency in manipulating multiplication and division equations here in the calculation and fluency section: [4MD-2](#)

Making connections

Being able to move between the grouping and sharing structures of division supports calculation. For example, irrespective of the calculation context, pupils may find it more helpful to think of the sharing (partitive) structure when calculating $1,600 \div 2$ (1,600 shared or partitioned into 2 equal shares/parts is 800), rather than thinking about the grouping structure (800 twos in 1,600). Conversely, pupils may find it more helpful to think of $200 \div 25$ in terms of the grouping (quotitive) structure (how many groups of 25 there are in 200) rather than thinking about the sharing structure (200 shared or partitioned into 25 equal shares).

4MD–2 Example assessment questions

- Using pictures of vases of flowers, draw two pictures which can be represented by the equation $5 \times 4 = 20$.
- Write as many multiplication and division equations as you can to represent each picture.

a.

1,000			
250	250	250	250

b.



- Write a story that could be represented by this equation $3 \times 7 = 21$.
- Using pictures of apples in bowls, draw 2 pictures which can be represented by the equation $18 \div 3 = 6$.
- Use $15 \times 16 = 240$ to write 3 other related multiplication and division equations.
- 45kg of animal feed is shared between some horses. They each get 5kg. How many horses were there?
- 1m 40cm of ribbon was cut into equal pieces. Each piece is 14cm long. How many pieces of ribbon are there?
- Fill in the missing numbers.

$$\boxed{} \div 20 = 5$$

$$3,000 \div \boxed{} = 250$$

$$\boxed{} \times 100 = 5,400$$

4MD–3 The distributive property of multiplication

Understand and apply the distributive property of multiplication.

4MD–3 Teaching guidance

The first place that pupils will have encountered the distributive law is within the multiplication tables themselves. Pupils have seen, for example, that adjacent multiples in the 6 times table have a difference of 6. Number lines and arrays can be used to illustrate this.

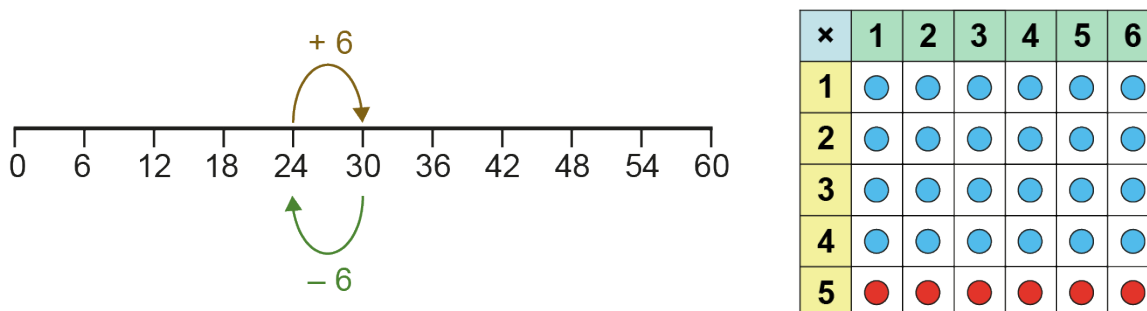

Figure 22: number line and array showing that adjacent multiples of 6 (24 and 30) have a difference of 6

Pupils should be able to represent such relationships using mixed operation equations, for example:

$$5 \times 6 = 4 \times 6 + 6 \quad \text{or} \quad 5 \times 6 = 4 \times 6 + 1 \times 6$$

$$4 \times 6 = 5 \times 6 - 6 \quad \text{or} \quad 4 \times 6 = 5 \times 6 - 1 \times 6$$

Pupils should learn that multiplication takes precedence over addition.

They should then extend this understanding beyond the multiplication tables, for example, if they are given the equation $20 \times 6 = 120$, they should be able to determine that $21 \times 6 = 126$, or vice versa.

Pupils also need to be able to apply the distributive property to non-adjacent multiples. The array chart used to show the connection between 4×6 and 5×6 can be adapted to show the connection between 5×6 , 3×6 and 2×6 .

×	1	2	3	4	5	6
1	●	●	●	●	●	●
2	●	●	●	●	●	●
3	●	●	●	●	●	●
4	●	●	●	●	●	●
5	●	●	●	●	●	●

Figure 23: Array showing the relationship between 5×6 , 3×6 and 2×6

As for adjacent multiples, pupils should be able to use mixed operation equations to represent the relationships:

$$5 \times 6 = 3 \times 6 + 2 \times 6$$

$$3 \times 6 = 5 \times 6 - 2 \times 6$$

$$2 \times 6 = 5 \times 6 - 3 \times 6$$

Again, pupils should understand that multiplication takes precedence: the multiplications are calculated first, and then the products are added or subtracted.

Pupils can use language patterns to support their reasoning.

Language focus

“5 is equal to 3 plus 2, so 5 times 6 is equal to 3 times 6 plus 2 times 6.”

This illustrates the distributive property of multiplication:

$$a \times (b + c) = a \times b + a \times c \quad \text{and} \quad a \times (b - c) = a \times b - a \times c$$

Note that the examples of adjacent multiples above are simply a special case of this in which b or c is equal to 1.

Pupils should then use the distributive property and known multiplication table facts to multiply 2-digit numbers (above 12) by one-digit numbers. 14×3 , for example, can be calculated by relating it to 10×3 and 4×3 :

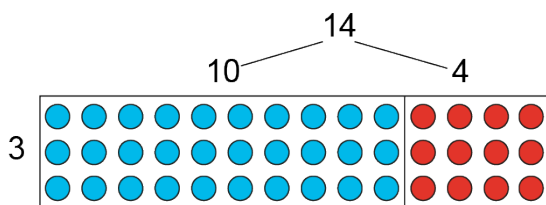

$$\begin{aligned}
 14 \times 3 &= 10 \times 3 + 4 \times 3 \\
 &= 30 + 12 \\
 &= 42
 \end{aligned}$$

Figure 24: array showing the relationship between 14×3 , 10×3 and 4×3

Pupils should recognise that factors can be partitioned in ways other than into ‘10 and a bit’. For example 14×3 could also be related to double 7×3 .

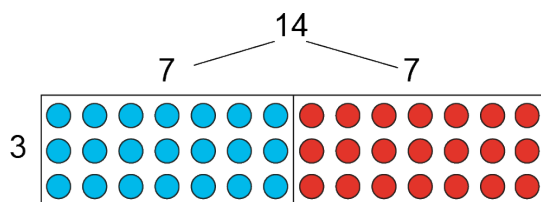

$$\begin{aligned}
 14 \times 3 &= 7 \times 3 + 7 \times 3 \\
 &= 21 + 21 \\
 &= 42
 \end{aligned}$$

Figure 25: array showing that 14×3 is double 7×3

Pupils should be expected to extend their understanding of the distributive law to support division. For example, they should be able to connect a calculation such as $65 \div 5$ to known multiplication and division facts: “we have 3 more fives than 10 fives” or “we have 1 more 5 than 12 fives”.

Making connections

Pupils need to be fluent in multiplication tables to 9×9 ([4NF-1](#)) and be able to multiply by 10 ([4MD-1](#)) to be able to efficiently apply the distributive property.

Mastery of this criterion supports fluency in the 11 and 12 multiplication tables, since multiplication by 11 or 12 can be derived from multiplication by 10 and by 1 or 2, using the distributive property. The formal written methods of multiplication also depend upon the distributive property of multiplication.

4MD–3 Example assessment questions

1. I had 6 flowers, each with 8 petals. If I get one more flower, how many petals do I have altogether?
2. Jordan buys 10 packs of soft drinks for a party. Each pack contains 6 cans. One pack is lemonade and the rest are cola. How many cans of cola are there?
3. I have a 65cm length of string. How many 5cm lengths can I make from it?
4. Fill in the missing symbols (<, > or =).

$$4 \times 6 \square 5 \times 6 - 6$$

$$4 \times 6 \square 3 \times 6 + 3$$

$$4 \times 6 \square 3 \times 6 + 6$$

$$4 \times 6 \square 6 \times 4$$

$$4 \times 6 \square 5 \times 6$$

$$6 \times 5 \square 4 \times 6$$

5. Fill in the missing numbers.

$$4 \times 7 = 3 \times 7 + \square$$

$$16 \times 4 = 10 \times 4 + \square \times 4$$

$$16 \times 4 = 8 \times 4 + \square \times 4$$

6. A box of chocolates costs £7. How much do 16 boxes cost?
7. Felicity is putting flowers into bunches of 5. So far she has made 4 bunches. She has 15 more flowers.
 - a. How many bunches will she make altogether?
 - b. How many flowers does she have altogether?
8. $3 \times 72 = 216$

Explain how you can use this fact to calculate:

- a. 3×73

- b. 4×72

4F–1 Mixed numbers in the linear number system

Reason about the location of mixed numbers in the linear number system.

4F–1 Teaching guidance

Sometimes pupils get quite far in their maths education only thinking of a fraction as a part of a whole, rather than as a number in its own right. In year 3, pupils learnt about the location in the linear number system of fractions between 0 and 1 (**3F–2**). For pupils to be able to add and subtract fractions across 1, or those greater than 1 (**4F–3**), they need to understand how mixed numbers fit into the linear number system.

Pupils should develop fluency counting in multiples of unit fractions, using number lines for support. Counting draws attention to the equivalence of, for example, $1\frac{4}{4}$ and 2, or $2\frac{5}{5}$ and 3. Pupils should practise counting both forwards and backwards.

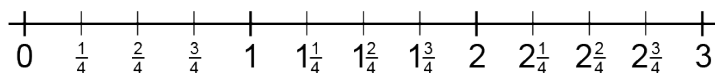

Figure 26: number line to support counting in multiples of one quarter

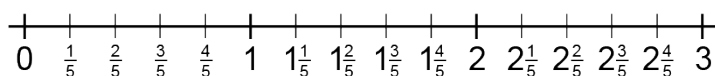

Figure 27: number line to support counting in multiples of one fifth

Pupils should then learn to label marked number lines, extending beyond 1. A common mistake that pupils make is to count the number of marks between labelled intervals, rather than the number of parts. For example, on the number line below they may count 3 marks and incorrectly deduce that the number line is marked in thirds.

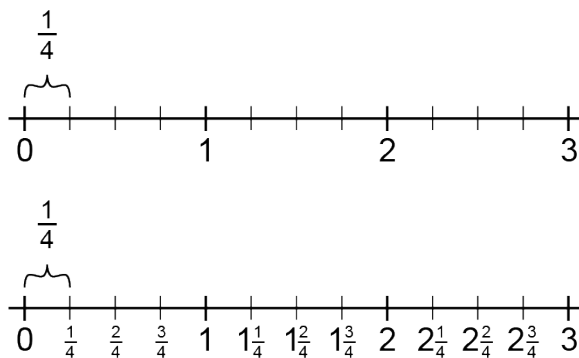

Figure 28: labelling a number line marked in quarters

Language focus

“Each interval is divided into 4 equal parts, so we count in quarters.”

Pupils should also be able to estimate the value or position of mixed numbers on number lines which do not have fractional marks. Pupils must understand that it is not the absolute size of the numerator and denominator which determine the value of the fractional part of the mixed number, but the *relationship* between the numerator and denominator (whether the numerator is a large or small part of the denominator). Pupils need to be able to reason, for example, that $1\frac{7}{8}$ is close to 2, but that $1\frac{7}{30}$ is closer to 1.

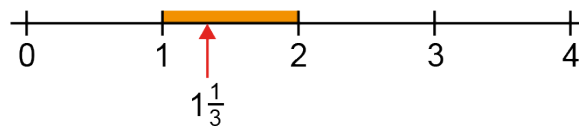

Figure 29: placing a mixed number on a number line with no fractional marks

Pupils must also be able to identify the previous and next whole number, and will then be able to round to the nearest whole number, which further supports estimation and approximation.

Language focus

“ $1\frac{1}{3}$ is between 1 and 2.”

“The previous whole number is 1.”

“The next whole number is 2.”

Making connections

Having a visual image of mixed numbers in the linear number system helps pupils to add and subtract fractions with the same denominator (including mixed numbers), for example $4\frac{2}{5} - \frac{3}{5}$ (**4F-3**). It also supports comparison of mixed numbers, and reading scales.

4F-1 Example assessment questions

1. Add labels to each mark on the number lines.

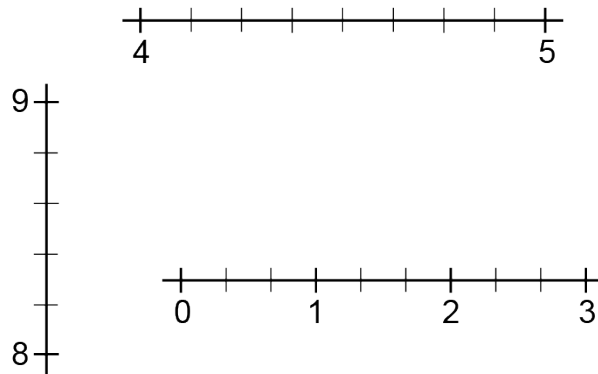

2. What are the values of a, b, c and d?

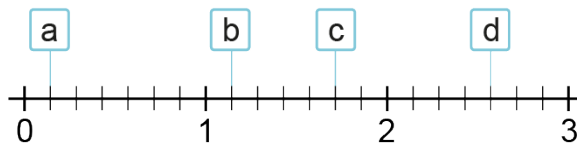

3. Estimate the position of the following numbers on the number line.

$$2\frac{2}{9} \qquad \frac{2}{3} \qquad 3\frac{3}{7} \qquad 1\frac{1}{5}$$

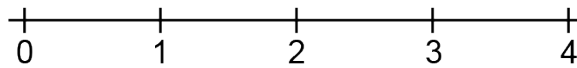

4. How much water is in the beaker? Write your answer as a mixed number.

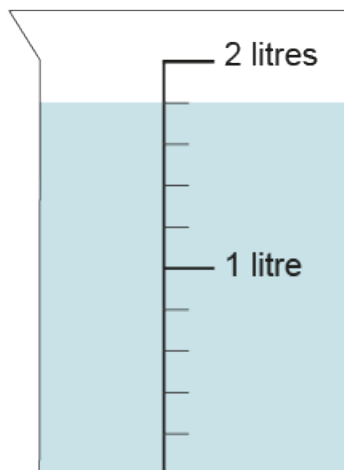

5. Circle the larger number in each of these pairs. Explain your reasoning.

$$3\frac{3}{9} \quad 3\frac{8}{9} \qquad 4\frac{1}{3} \quad 4\frac{1}{8} \qquad 2\frac{1}{3} \quad 1\frac{2}{3}$$

4F–2 Convert between mixed numbers and improper fractions

Convert mixed numbers to improper fractions and vice versa.

4F–2 Teaching guidance

It should be noted that this criterion covers content that is in year 5 of the national curriculum. It has been included here, in year 4, to improve coherence. Pupils have already learnt that fractions where the numerator is equal to the denominator have a value of 1. This knowledge should be extended to other integers. For example, if we know that $\frac{5}{5} = 1$, we can repeat groups of $\frac{5}{5}$ to see that $\frac{10}{5} = 2$ and $\frac{15}{5} = 3$ and so on.

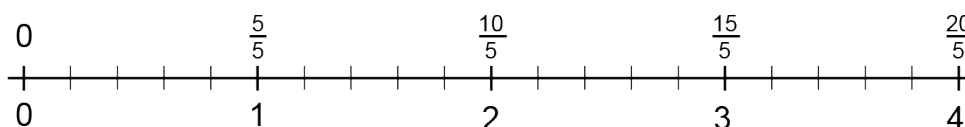

Figure 30: number line showing integers expressed as fractions

Language focus

“When the numerator is a multiple of the denominator, the fraction is equivalent to a whole number.”

Pupils can then learn to express mixed numbers as improper fractions.

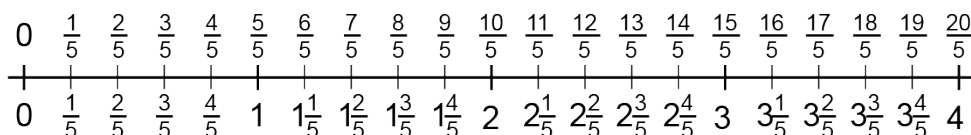

Figure 31: number line showing mixed number–improper fraction equivalence

To convert from mixed numbers to improper fractions, pupils should use their multiplication tables facts to find the improper-fraction equivalent to the integer part of the mixed number, and then add on the remaining fractional part.

1 m					1 m					$\frac{1}{5}m$	$\frac{1}{5}m$	$\frac{1}{5}m$	
$\frac{1}{5}m$	$\frac{1}{5}m$	$\frac{1}{5}m$	$\frac{1}{5}m$	$\frac{1}{5}m$	$\frac{1}{5}m$	$\frac{1}{5}m$	$\frac{1}{5}m$	$\frac{1}{5}m$	$\frac{1}{5}m$	$\frac{1}{5}m$	$\frac{1}{5}m$	$\frac{1}{5}m$	$\frac{1}{5}m$

$$2\frac{3}{5}m = \frac{13}{5}m$$

Figure 32: bar model showing mixed number–improper fraction equivalence

Language focus

“There are 2 groups of five-fifths, which is 10 fifths and 3 more fifths. This is 13 fifths.”

Pupils should then learn to convert in the other direction – from improper fractions to mixed numbers. Pupils need to understand the improper fraction in terms of a multiple of a unit fraction. For example, they should be able to see $\frac{21}{8}$ as 21 one-eighths. Pupils can initially use unit-fraction counters (here, $\frac{1}{8}$ value counters) to represent this. Conversion to a mixed number then builds on division with remainders (**4NF-2**). In this example, since 8 one-eighths is equal to 1 whole, pupils must find how many wholes can be made from the 21 eighths, and how many eighths are left over.

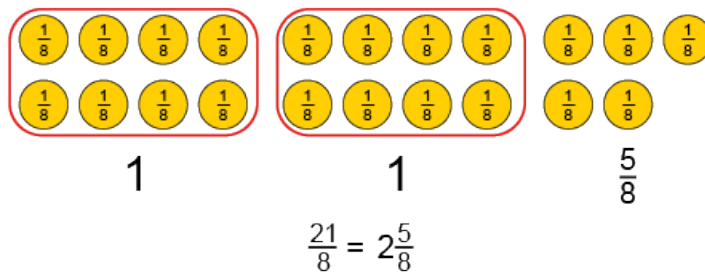

Figure 33: using unit fraction counters to support conversion from an improper fraction to a mixed number

Language focus

“We have 21 eighths. 8 eighths is equal to 1 (whole).”

“21 eighths is equal to 2 groups of 8 eighths, and 5 more eighths. This is 2 and 5 eighths.”

Once pupils have an understanding of the conversion process, they should not need to use counters or other similar manipulatives or drawings.

Making connections

For pupils to succeed with this criterion, they must first be fluent in multiplication facts (**4NF-1**) and division with remainders (**4NF-2**). Converting, for example, $3\frac{1}{6}$ to an improper fraction involves calculating $3 \times 6 + 1$ (**4NF-1**). The reverse process, (converting $\frac{19}{6}$ to a mixed number) involves calculating $19 \div 6 = 3 \text{ r } 1$ (**4NF-2**).

Converting between mixed numbers and improper fractions also supports efficient addition and subtraction of fractions with the same denominator (**4F-3**). Being able to move easily between the two will allow pupils to choose the most efficient calculation approach.

4F-2 Example assessment questions

1. Which of these fractions are equivalent to a whole number? Explain how you know.

$$\frac{48}{6} \quad \frac{48}{7} \quad \frac{48}{8} \quad \frac{48}{9} \quad \frac{48}{10}$$

2. Express the following mixed numbers as improper fractions.

$$4\frac{1}{8} \quad 6\frac{4}{9} \quad 3\frac{11}{12} \quad 8\frac{2}{3}$$

3. Express the following improper fractions as mixed numbers.

$$\frac{17}{2} \quad \frac{13}{6} \quad \frac{28}{10} \quad \frac{41}{7}$$

4. Sarah wants to convert $\frac{17}{4}$ to a mixed number. She writes:

$$\frac{17}{4} = 3\frac{5}{4}$$

Explain what mistake Sarah has made, and write the correct answer.

5. The school kitchen has 17 packs of butter. Each pack weighs $\frac{1}{4}$ kg. How many kilograms of butter do they have altogether? Express your answer as a mixed number.
6. I have a $6\frac{1}{2}$ m length of string. How many $\frac{1}{2}$ m lengths can I cut?

4F–3 Add and subtract improper and mixed fractions (same denominator)

Add and subtract improper and mixed fractions with the same denominator, including bridging whole numbers, for example:

$$\frac{7}{5} + \frac{4}{5} = \frac{11}{5}$$

$$3\frac{7}{8} - \frac{2}{8} = 3\frac{5}{8}$$

$$7\frac{2}{5} + \frac{4}{5} = 8\frac{1}{5}$$

$$8\frac{1}{5} - \frac{4}{5} = 7\frac{2}{5}$$

4F–3 Teaching guidance

To meet this criterion, pupils must be able to carry out the following types of calculation (with a common denominator):

- add and subtract 2 improper fractions
- add and subtract a proper fraction to/from a mixed number
- add and subtract one mixed number to/from another

In year 3, pupils used their understanding that a non-unit fraction is a multiple of a unit fraction, for example, $\frac{2}{5}$ is 2 lots of $\frac{1}{5}$. This allowed them to reason that $\frac{2}{5} + \frac{2}{5} = \frac{4}{5}$,

because 2 lots of $\frac{1}{5}$ plus 2 lots of $\frac{1}{5}$ is equal to 4 lots of $\frac{1}{5}$, or $\frac{4}{5}$.

Pupils should now apply this strategy to addition and subtraction involving improper fractions.

Language focus

“7 one-fifths plus 4 one-fifths is equal to 11 one-fifths.”

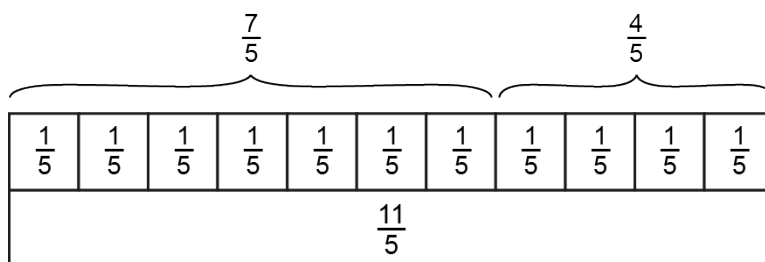

$$\frac{7}{5} + \frac{4}{5} = \frac{11}{5}$$

Figure 34: bar model showing addition of improper fractions with the same denominator

The generalisation that pupils learnt for adding and subtracting fractions with the same denominator within 1 whole therefore also extends to improper fractions.

Language focus

“When adding fractions with the same denominators, just add the numerators.”

“When subtracting fractions with the same denominators, just subtract the numerators.”

When adding and subtracting mixed numbers, pupils can convert them to improper fractions and apply this generalisation. This is sometimes a good approach. However this isn't always necessary, or the most efficient choice, and pupils should learn to use their knowledge of the composition of mixed numbers to add and subtract.

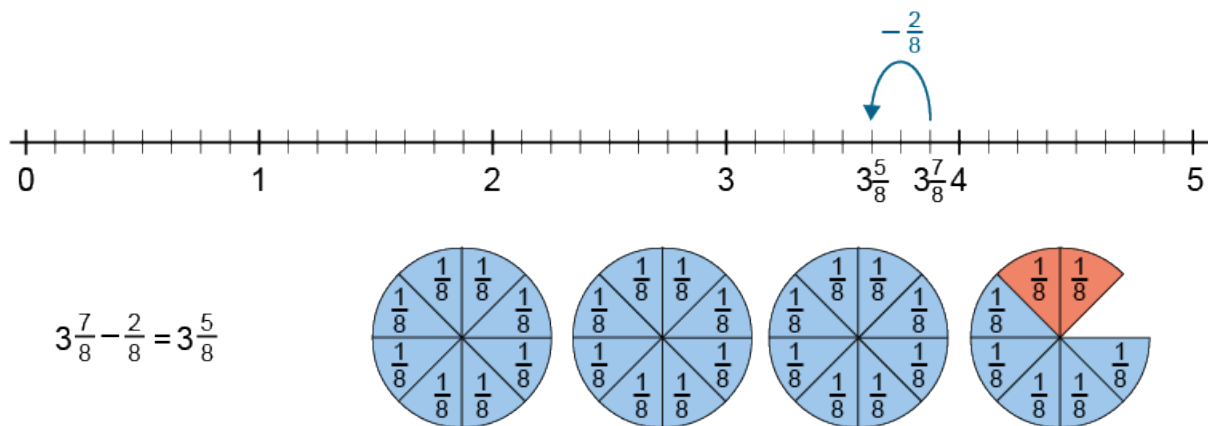

Figure 35: number line and pie model showing subtraction of a fraction from a mixed number (same denominator)

Pupils must also be able to add and subtract across a whole number, for example:

$$7\frac{2}{5} + \frac{4}{5} = 8\frac{1}{5}$$

$$8\frac{1}{5} - \frac{4}{5} = 7\frac{2}{5}$$

Addition strategies include:

- adding to reach the whole number, then adding the remaining fraction

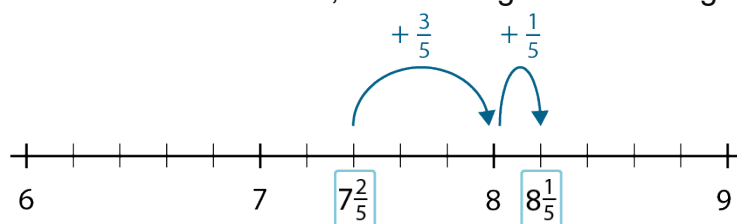

Figure 36: number line showing strategy for adding across a whole number

- adding the fractional parts first to give an improper fraction, which is then converted to a mixed number and added

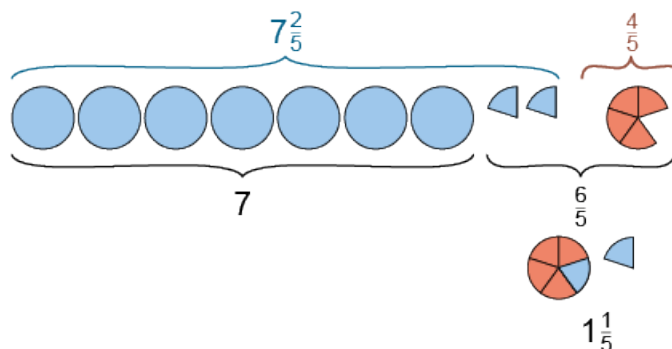

Figure 37: pie model showing strategy for adding across a whole number

Before pupils attempt to subtract across a whole number (for example, $8\frac{1}{5} - \frac{4}{5}$), they should first learn to subtract a proper fraction from a whole number (for example, $8 - \frac{3}{5}$). Pupils can find this challenging, so number lines and bar or pie models can be useful.

Once pupils can do this, they should be able to subtract across the whole number by using:

- a ‘subtracting through the whole number’ strategy (partitioning the subtrahend) – part of the subtrahend is subtracted to reach the whole number, then the rest of the subtrahend is subtracted from the whole number

or

- a ‘subtracting from the whole number’ strategy (partitioning the minuend) – the subtrahend is subtracted from the whole number part of the minuend, then the remaining fractional part of the minuend is added

Subtracting through the whole number

Subtracting from the whole number

$$\begin{aligned} 8\frac{1}{5} - \frac{4}{5} &= 8\frac{1}{5} - \frac{1}{5} - \frac{3}{5} \\ &= 8 - \frac{3}{5} \\ &= 7\frac{2}{5} \end{aligned}$$

$$\begin{aligned} 8\frac{1}{5} - \frac{4}{5} &= 8 - \frac{4}{5} + \frac{1}{5} \\ &= 7\frac{1}{5} + \frac{1}{5} \\ &= 7\frac{2}{5} \end{aligned}$$

Finally, pupils need to be able add one mixed number to another, and subtract one mixed number from another.

$$4\frac{2}{9} + 1\frac{3}{9} = 5\frac{5}{9}$$

$$5\frac{5}{9} - 1\frac{3}{9} = 4\frac{2}{9}$$

Pupils should initially solve problems where addition or subtraction of the fractional parts does *not* bridge a whole number. Both pie models, as above, and partitioning diagrams

can be used to support addition, by partitioning both of the mixed numbers into their whole number and fractional parts.

Pupils should not extend the method for addition – partitioning *both* mixed fractions – to subtraction of one mixed number from another. Pupils should instead use a similar strategy to that used for subtraction of one two-digit number from another (**2AS–2**), only partitioning the subtrahend.

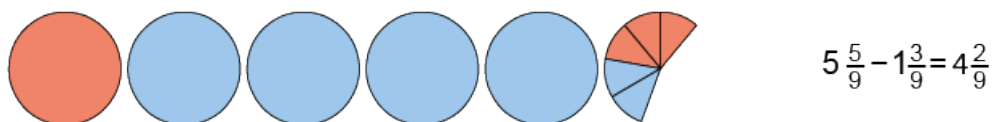

Figure 38: pie model showing strategy for subtracting across a whole number

This is important when subtraction of the fractional parts bridges a whole number, to avoid pupils writing a calculation that involves negative fractions.

Making connections

In **4F–2**, pupils learnt to convert between improper fractions and mixed numbers. One strategy for adding and subtracting mixed numbers is to convert them to improper fractions before adding/subtracting and then to convert the answer back again. Pupils also need to draw on these conversions when addition of mixed numbers results in an improper fraction. For example, pupils should be expected to convert an answer such as $2 \frac{9}{7}$ to $3 \frac{2}{7}$.

In **4F–1**, pupils learnt to position mixed numbers on a number line. This supports bridging through a whole number, for example understanding that $8 \frac{1}{5} - \frac{4}{5} = 7 \frac{2}{5}$.

Some of the strategies covered in this criterion are analogous to those that pupils have used for whole numbers. The 2 strategies presented for adding and subtracting across a whole number mirror those for adding and subtracting across 10, which pupils learnt in year 2 (**2NF–1**). The strategies presented for adding and subtracting two mixed numbers mirror those for adding and subtracting 2 two-digit numbers (**2AS–2**) – for addition, partition both addends; and for subtraction, partition only the subtrahend. If pupils can see these connections, they will be able to calculate more confidently with fractions, seeing them as just another type of number.

4F–3 Example assessment questions

1. It is a $2\frac{3}{4}$ km cycle ride to my friend's house, and a further $\frac{3}{4}$ km ride to the park. How far do I have to cycle altogether?
2. I have 5m of rope. I cut off $\frac{4}{10}$ m. How much rope is left?
3. Fill in the missing numbers.

$2\frac{1}{7}$	$2\frac{4}{7}$			$3\frac{6}{7}$	
----------------	----------------	--	--	----------------	--

4. The table below shows the number of hours Josie read each day during a school week. For how long did Josie read altogether?

Mon	Tues	Wed	Thurs	Fri
$1\frac{3}{4}$ hours	1 hour	$1\frac{1}{4}$ hours	$1\frac{1}{4}$ hours	$2\frac{3}{4}$ hours

5. A tailor has $3\frac{7}{10}$ m of ribbon. She uses $1\frac{9}{10}$ m to complete a dress. How much ribbon is left?

4G–1 Draw polygons specified by coordinates or by translation

Draw polygons, specified by coordinates in the first quadrant, and translate within the first quadrant.

4G–1 Teaching guidance

Pupils should already be adept at placing markings at specific points, and joining these accurately with a ruler to draw a polygon (**3G–1**).

Pupils can begin by describing translations of polygons drawn on squared paper, by counting how many units to the left/right and up/down the polygon has been translated.

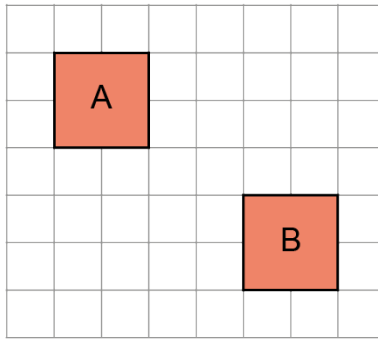

Figure 39: translation of a polygon on a square grid

Language focus

“The polygon has been translated 4 squares to the right and 3 squares down.”

Pupils should then learn to translate polygons on squared paper according to instructions that describe how many units to move the polygon to the left/right and up/down. Pupils can translate each point of the polygon individually, for example, translating each point right 4 and down 3 to mark the new points, and then joining them. Alternatively, pupils can translate and mark one point, then mark the other points of the polygon relative to the translated point.

In year 4, pupils must start to use coordinate geometry, beginning with the first quadrant. Initially, pupils can work with axes with no number labels, marking specified points as a translation from the origin, described as above.

For example, “Start at the origin and mark a point along 5, and up 4.”

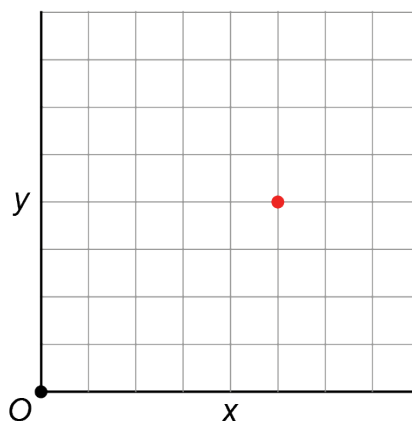

Figure 40: marking a point relative to the origin (O) on a grid with no number labels

Finally, pupils should learn to use coordinate notation with number labels on the axes. They must be able to mark the position of points specified by coordinates, and write coordinates for already marked points.

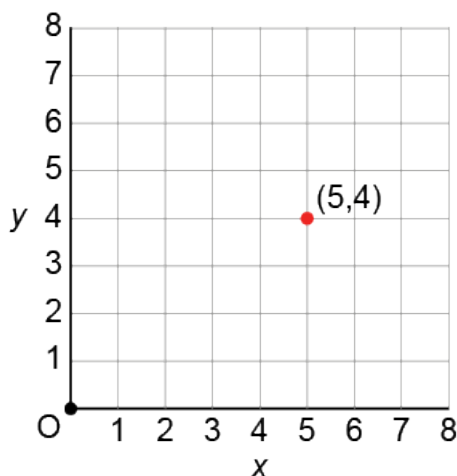

Figure 41: marking a point on a grid with number labels

When pupils first start to mark points, they should still start at the origin, moving along and then up as specified by the coordinates. If they do not do this, they are likely to place a point such as (5, 4) by just looking for a 5 and a 4, and possibly end up placing the point at (4, 5).

Language focus

“First count along the x-axis, then count along the y-axis.”

Pupils should then be able to draw polygons by marking and joining specified coordinates.

Making connections

In [4NPV-3](#) , [4NPV-4](#) and [4F-1](#), and in previous year groups, pupils learnt to place or identify specified points (numbers) on a number line or scale. In this criterion children learn to place or identify specified points with reference to 2 number lines.

4G–1 Example assessment questions

1. Translate the quadrilateral so that point A moves to point B.

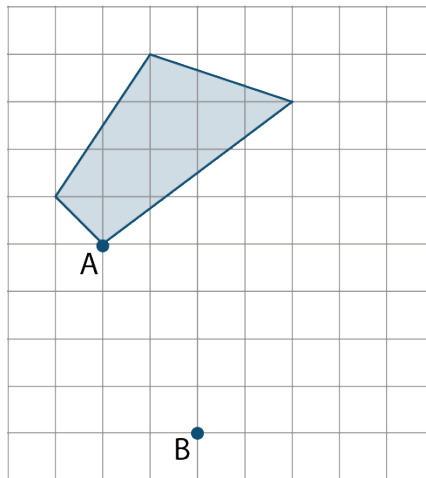

2. A kite has been translated from position A to position B. Describe the translation.

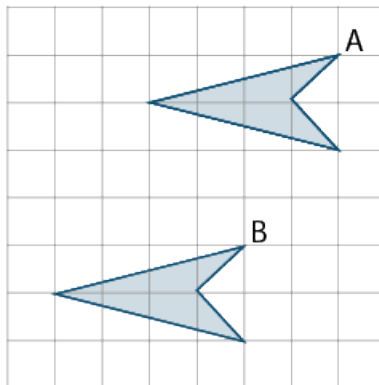

3. Mark the points, and join them to make a square.

(3,1)

(2,4)

(5,5)

(6,2)

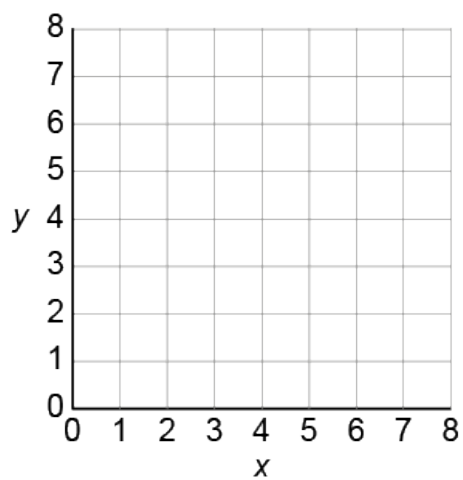

4. This triangle is translated so that point A moves to (4, 3). Draw the shape in its new position.

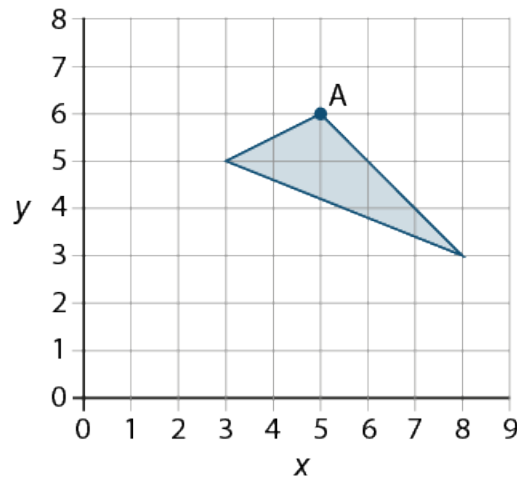

5. Mark the following points, and join them to make a polygon.

(5, 0) (3, 1) (5, 2) (7, 1)

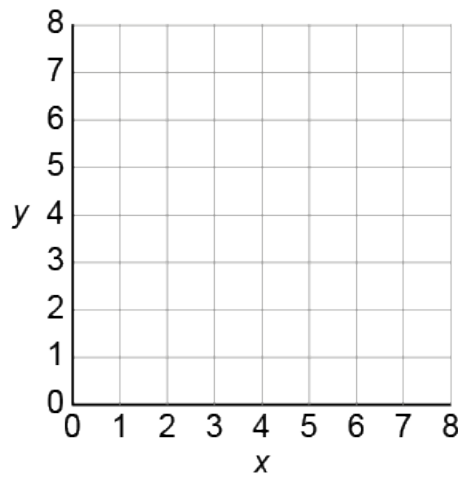

- b. What is the name of the polygon that you have drawn?
c. Translate the polygon you have just drawn left 2 and up 3. What are the coordinates of the vertices of this new polygon?

4G–2 Perimeter: regular and irregular polygons

Identify regular polygons, including equilateral triangles and squares, as those in which the side-lengths are equal and the angles are equal. Find the perimeter of regular and irregular polygons.

4G–2 Teaching guidance

Pupils must be able to identify regular polygons, and reason why a given polygon is regular.

Language focus

“This is a regular polygon, because all of the sides are the same length, and all of the interior angles are equal.”

Pupils often define a regular polygon as having equal side-lengths and neglect to mention the angles – it is important that pupils consider both sides and angles when assessing and describing whether a polygon is regular. Pupils should examine and discuss a wide range of irregular shapes, including examples with equal angles, but unequal side-lengths (shape **d** below), examples with equal angles, but unequal interior angles and unequal side-lengths (shape **c** below), and examples with equal side-lengths, but unequal angles (shape **e** below).

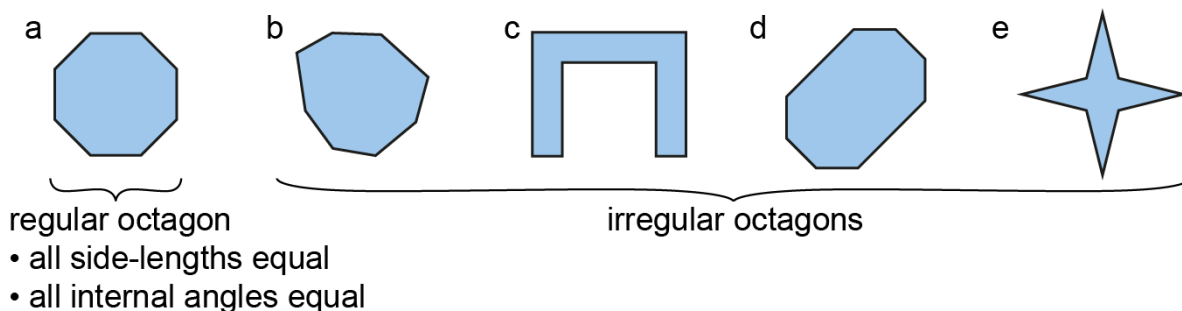
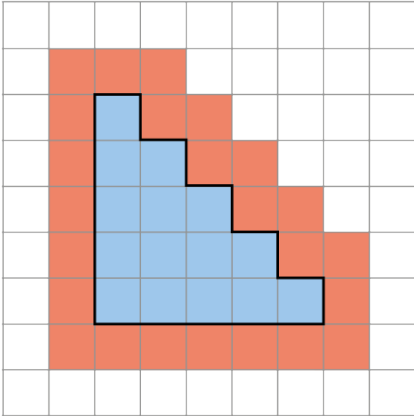
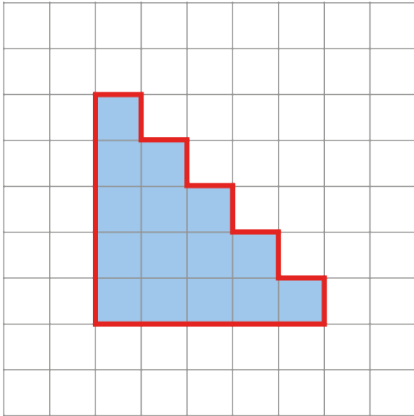



Figure 42: a regular octagon and 4 irregular octagons

Pupils can make different polygons with equal length geo-strips to explore regular shapes and irregular shapes with equal side-lengths but unequal angles. Pupils should compare angles using informal language, and begin to discuss whether angles are smaller than a right angle (acute), larger than a right angle but smaller than a ‘straight line’ (180°) (obtuse), or larger than a ‘straight line’ (180°) (reflex) in preparation for measuring angles with a protractor in year 5.

Pupils should also learn that equilateral triangles are regular triangles, and that squares are regular quadrilaterals.

Pupils need to understand perimeter as the total distance around the outside of a shape, and be able to measure or calculate the perimeter of shapes with straight sides. Pupils should be able to measure side-lengths in centimetres or metres, as appropriate, using skills developed from year 1 onwards. They should use an appropriate strategy to find the perimeter of a given polygon, according to the property of the shape.

Shape type	Strategy for calculating the perimeter
rectilinear shapes on centimetre-square-grids	<p>count the number of centimetre lines around the shape</p> <div style="display: flex; justify-content: space-around; align-items: flex-start;"> <div style="text-align: center;"> <p>incorrect</p>  <p>perimeter = 24cm</p> </div> <div style="text-align: center;"> <p>correct</p>  <p>perimeter = 20cm</p> </div> </div> <div style="text-align: right; margin-top: 10px;"> <p>1cm 1cm </p> </div> <p>Figure 43: incorrect and correct methods for finding the perimeter of a rectilinear shape on a square grid</p> <p style="text-align: right;"><i>Drawn to scale.</i></p>
polygons with equal side-lengths	<p>use multiplication:</p> <p>perimeter = side-length \times number of sides</p>
polygons with unequal side-lengths	<p>use addition:</p> <p>perimeter = sum of the side-lengths</p>

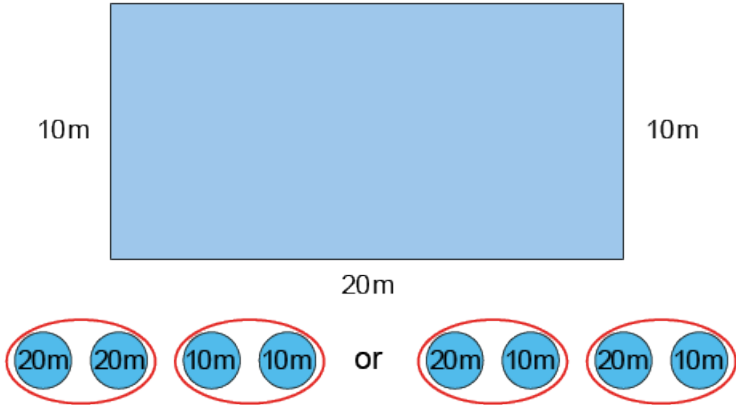
Shape type	Strategy for calculating the perimeter
rectangles	<p>use doubling and addition:</p> $\text{perimeter} = 2 \times (\text{length} + \text{width})$ <p>or</p> $\text{perimeter} = (2 \times \text{length}) + (2 \times \text{width})$  <p>Figure 44: 2 strategies for calculating the perimeter of a rectangle <i>Drawn to scale.</i></p>

As well as working with 'small' shapes in the classroom, pupils should gain experience working with larger shapes, such as calculating the perimeter of a rectilinear area drawn on the playground in metres.

Making connections

Pupils must be fluent in multiplication table facts ([4NF-1](#)) to efficiently calculate the perimeter of polygons with equal side-lengths. They must also be able to apply appropriate strategies for adding more than 2 numbers to calculate the perimeter of irregular polygons.

4G–2 Example assessment questions

1. Taro uses some 8cm sticks to make these shapes. Name each shape and find its perimeter.

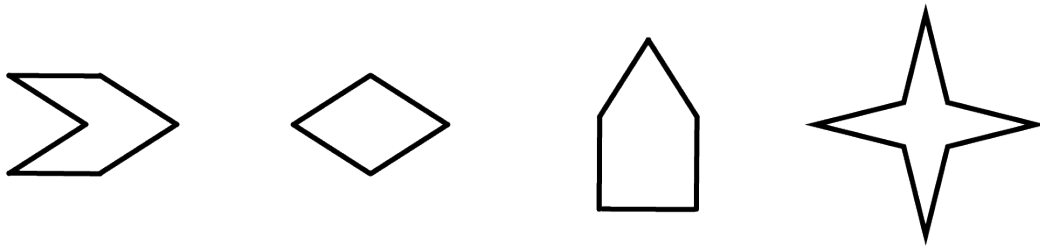

Drawn to scale.

2. What is the perimeter of this shape?

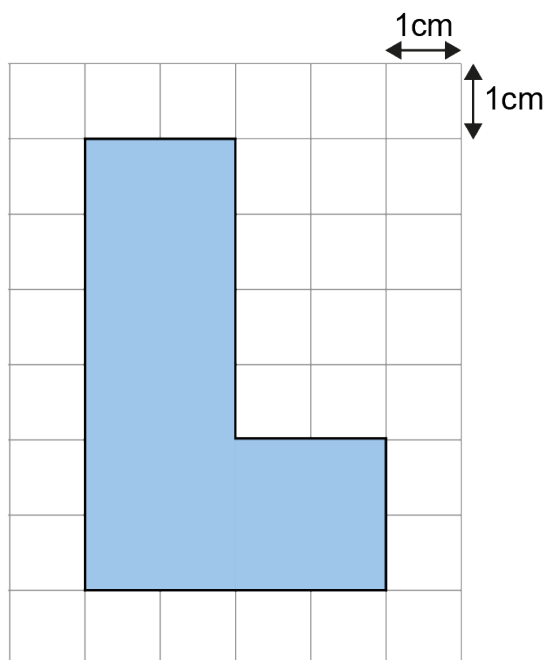

Drawn to actual size.

3. Sarah draws a rhombus with a perimeter of 36cm. What is the length of each side?
4. Here is a plan of a school playground. How many metres of fencing is needed to put a fence around the perimeter?

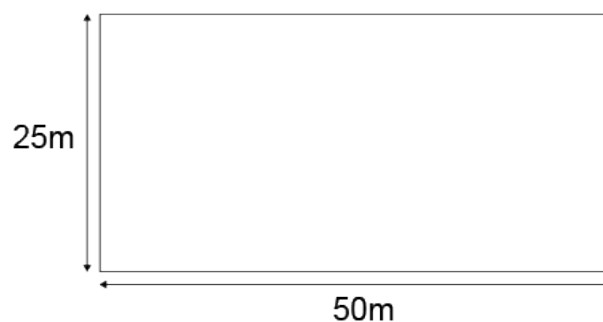

Drawn to scale.

5. Name each shape and say whether it is regular or irregular. Explain your reasons.

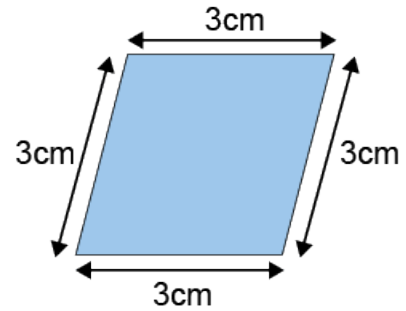
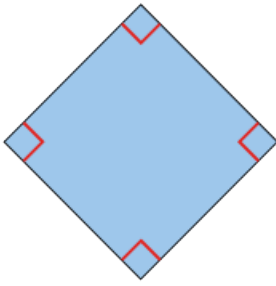

4G–3 Identify line symmetry in 2D shapes

Identify line symmetry in 2D shapes presented in different orientations. Reflect shapes in a line of symmetry and complete a symmetric figure or pattern with respect to a specified line of symmetry.

4G–3 Teaching guidance

Identifying line symmetry requires pupils to be able to decompose shapes: where line symmetry exists within a shape, the shape can be split into two parts which are a reflection of one another. Pupils should learn to compose a symmetrical shape from two congruent shapes.

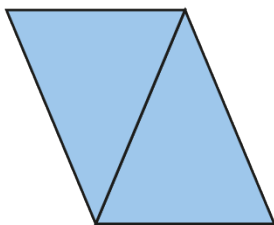

no line symmetry

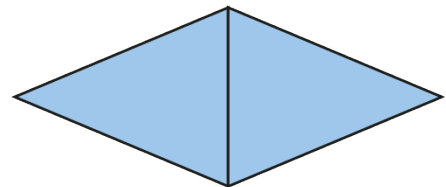
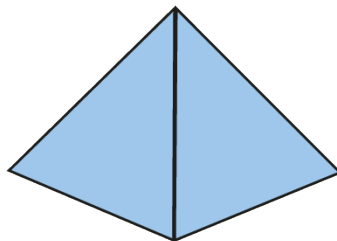

line symmetry

Figure 45: composing shapes from two identical isosceles triangles

Pupils should then learn to identify line symmetry in given symmetrical shapes. They can begin by folding or cutting paper shapes, or using a mirror, but should eventually be able to do this by mapping corresponding points in relation to the proposed line of symmetry. They should be able to explain why a particular shape is symmetrical, or why a given line is a line of symmetry.

Language focus

“This is a line of symmetry because it splits the shape into two equal parts which are mirror images.”

Pupils need to be able to identify line symmetry regardless of the orientation a shape is presented in, including cases where the line of symmetry is neither a horizontal nor a vertical line.

For the second part of this criterion, pupils must be able to reflect shapes in a line of symmetry, both where the line dissects the original shape (see [4G–3 Example assessment questions](#)) and where it does not, and complete symmetrical patterns.

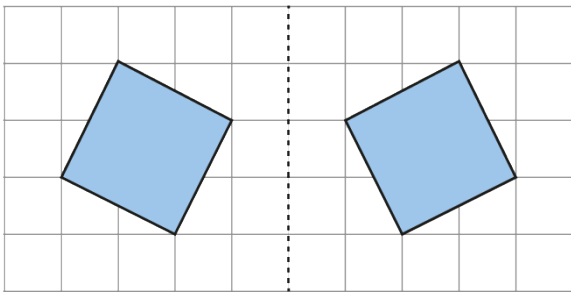

Figure 46: reflecting a shape in a line of symmetry

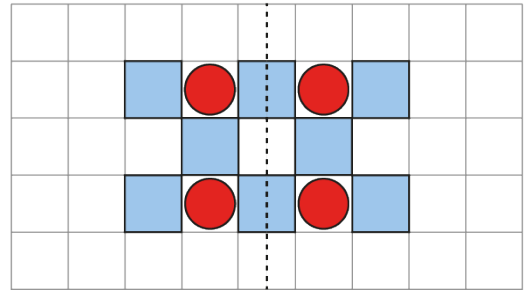
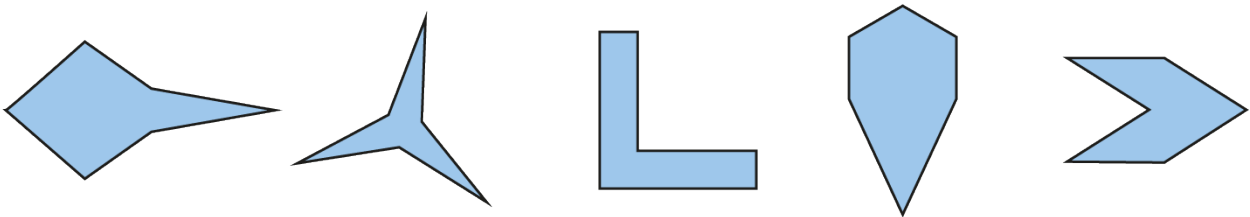

Figure 47: a symmetrical pattern

4G–3 Example assessment questions

1. Draw one or more lines of reflection symmetry in each of these irregular hexagons.



2. Reflect the three shapes in the mirror line.

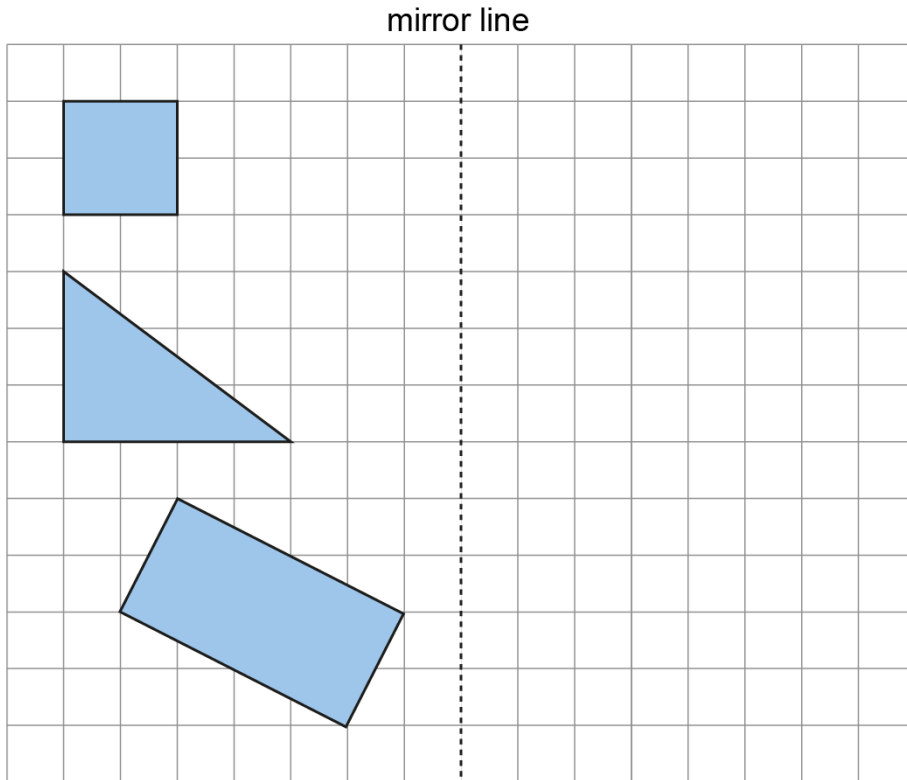

3. Complete the shape by reflecting it in the mirror line.

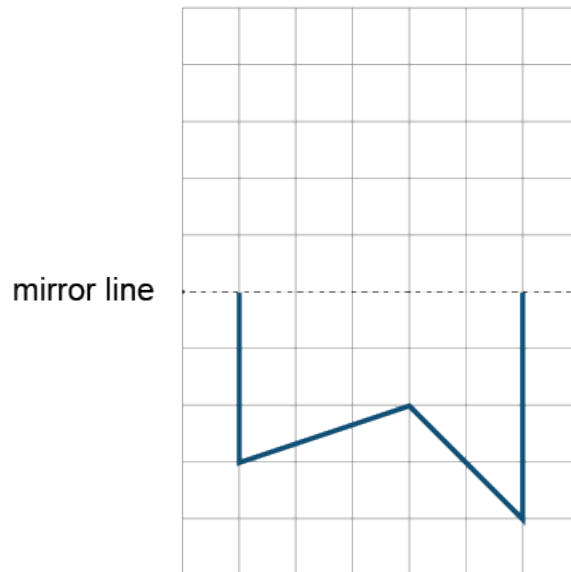

Name the polygon that you have completed.

4. Draw a line of symmetry on each shape. Are you able to draw more than one line of symmetry on any of the shapes?

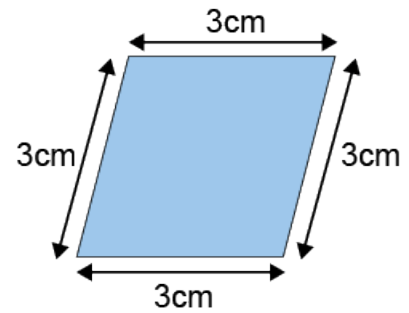
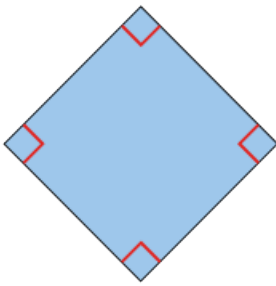

5. Complete the symmetrical pattern.

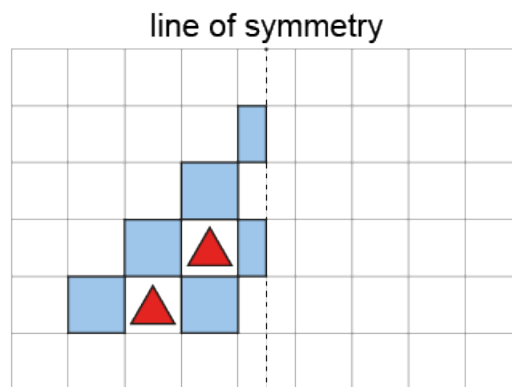

Calculation and fluency

Number, place value and number facts: 4NPV-2 and 4NF-3

- **4NPV-2** Recognise the place value of each digit in *four*-digit numbers, and compose and decompose four-digit numbers using standard and non-standard partitioning.
- **4NF-3** Apply place-value knowledge to known additive and multiplicative number facts (scaling facts by 100), for example:

$8 + 6 = 14$ and $14 - 6 = 8$	$3 \times 4 = 12$ and $12 \div 4 = 3$
so	so
$800 + 600 = 1,400$ and $1,400 - 600 = 800$	$300 \times 4 = 1,200$ and $1,200 \div 4 = 300$

Representations such as place-value counters and partitioning diagrams (**4NPV-2**) and tens-frames with place-value counters (**4NF-3**), can be used initially to help pupils understand calculation strategies and make connections between known facts and related calculations. However, pupils should not rely on such representations for calculating. For the calculations in **4NF-3**, for example, pupils should instead be able to calculate by verbalising the relationship.

Language focus

“8 plus 6 is equal to 14, so 8 hundreds plus 6 hundreds is equal to 14 hundreds.”

“14 hundred is equal to 1,400.”

Pupils should be developing fluency in both formal written and mental methods for addition and subtraction. Mental methods can include jottings to keep track of calculation, or language structures as exemplified above. Pupils should select the most efficient method to calculate depending on the numbers involved.

Addition and subtraction: extending 3AS–3

Pupils should also extend columnar addition and subtraction methods to four-digit numbers.

Pupils must be able to add 2 or more numbers using columnar addition, including calculations whose addends have different numbers of digits.

$$\begin{array}{r} 6,584 \\ + 2,739 \\ \hline 9,323 \\ \hline 1\ 1\ 1 \end{array}$$
$$\begin{array}{r} 3,362 \\ + 649 \\ \hline 4,011 \\ \hline 1\ 1\ 1 \end{array}$$
$$\begin{array}{r} 1,649 \\ 3,104 \\ + 516 \\ \hline 5,269 \\ \hline 1\ 1 \end{array}$$

Figure 48: columnar addition for calculations involving four-digit numbers

For calculations with more than 2 addends, pupils should add the digits within a column in the most efficient order. For the third example above, efficient choices could include:

- beginning by making 10 in the ones column
- making double-6 in the hundreds column

Pupils must be able to subtract one four-digit number from another using columnar subtraction. They should be able to apply the columnar method to calculations where the subtrahend has fewer digits than the minuend, and must be able to exchange through 0.

$$\begin{array}{r}
 \begin{array}{ccccccc}
 & 5 & 1 & 4 & 1 & 2 & 1 \\
 6, & 5 & 3 & 8 & & & \\
 - & 2, & 7 & 8 & 9 & & \\
 \hline
 3, & 7 & 4 & 9 & & &
 \end{array}
 &
 \begin{array}{r}
 2, 7 9 6 \\
 - \quad 4 8 5 \\
 \hline
 2, 3 1 1
 \end{array}
 &
 \begin{array}{r}
 \begin{array}{ccccccc}
 & 3 & 1 & 9 & 1 \\
 8, & 4 & 0 & 3 & & & \\
 - & 2, & 1 & 7 & 6 & & \\
 \hline
 6, & 2 & 2 & 7 & & &
 \end{array}
 \end{array}
 \end{array}$$

Figure 49: columnar subtraction for calculations involving four-digit numbers

Pupils should make sensible decisions about how and when to use columnar subtraction. For example, when the minuend is a multiple of 1,000, they may transform to an equivalent calculation before using column subtraction, avoiding the need to exchange through zeroes.

$$\begin{array}{r}
 7, 0 0 0 \\
 - 2, 6 4 8 \\
 \hline
 \hline
 \end{array}
 \xrightarrow[-1]{-1}
 \begin{array}{r}
 6, 9 9 9 \\
 - 2, 6 4 7 \\
 \hline
 \hline
 \end{array}$$

Figure 50: transforming a columnar subtraction calculation to an equivalent calculation

4NF–1 Recall of multiplication tables

Recall multiplication and division facts up to 12×12 , and recognise products in multiplication tables as multiples of the corresponding number.

Recall of all multiplication table facts should be the main multiplication calculation focus in year 4. Pupils who leave year 4 fluent in these facts have the best chance of mastering short multiplication in year 5.

Pupils who are fluent in multiplication table facts can solve the following types of problem by automatic recall of the relevant fact rather than by skip counting or reciting the relevant multiplication table:

- $8 \times 9 = \square$ $\square = 3 \times 12$ $6 \times 6 = \square$
(identify products)
- $\square \times 5 = 45$ $8 \times \square = 48$ $121 = \square \times 11$
(solve missing-factor problems)
- $35 \div 7 = \square$ $\square = 63 \div 9$
(use relevant multiplication table facts to solve division problems)

Pupils should also be fluent in interpreting contextual multiplication and division problems, identifying the appropriate calculation and solving it using automatic recall of the relevant fact. Examples are given in [4NF–1 Example assessment questions](#).

As pupils become fluent with the multiplication table facts, they should also develop fluency in related calculations as described in [4NF–3](#) (scaling number facts by 100). Pupils should also develop fluency in multiplying and dividing by 10 and 100 ([4MD–1](#)).

4MD–2 Manipulating the multiplicative relationship

Manipulate multiplication and division equations, and understand and apply the commutative property of multiplication.

Pupils who are fluent in manipulating multiplicative expressions can solve the following types of problem:

- $\square \div 4 = 7$ $6 = \square \div 5$ $9 = \square \div 9$
(apply understanding of the inverse relationship between multiplication and division to solve missing-dividend problems)
- $72 \div \square = 8$ $35 \div \square = 5$ $81 \div \square = 9$
(solve missing-divisor problems)

To solve missing-divisor problems, pupils can use their understanding that the divisor and the quotient can be swapped, so that $72 \div \square = 8$, for example, is solved using $72 \div 8$. Alternatively they can use their understanding of the relationship between multiplication and division, and solve the related missing-factor problem (here $8 \times \square = 72$). In either case, pupils will then need to apply their multiplication table fluency (here '9 eights are 72') to finally identify the missing divisor.



Department
for Education



National Centre
for Excellence in the
Teaching of Mathematics

© Crown copyright 2020

This publication (not including logos) is licensed under the terms of the Open Government Licence v3.0 except where otherwise stated. Where we have identified any third party copyright information you will need to obtain permission from the copyright holders concerned.

To view this licence:

visit www.nationalarchives.gov.uk/doc/open-government-licence/version/3

email psi@nationalarchives.gsi.gov.uk

write to Information Policy Team, The National Archives, Kew, London, TW9 4DU

About this publication:

enquiries www.education.gov.uk/contactus

download www.gov.uk/government/publications

Reference: DfE-00113-2020



Follow us on Twitter:
[@educationgovuk](https://twitter.com/educationgovuk)



Like us on Facebook:
facebook.com/educationgovuk